



*mod. 1957*

# Vespa 150

CATALOGO DELLE PARTI DI RICAMBIO  
LIST OF SPARE PARTS

PER VEICOLI CON PREFISSI TELAIO-MOTORE [www.piaggio.com](http://www.piaggio.com)  
FOR SCOOTERS WITH CHASSIS-ENGINE PREFIXES: } VB 1



## A V V E R T E N Z E

Il presente catalogo è costituito da 18 tavole, sulle quali sono elencati tutti i particolari fornibili come ricambi per le Vespa 150 con prefisso VB 1, prodotte nell'anno 1957.

I particolari e numeri di disegno riportati in rosso sulle tavole e contraddistinti col segno + di non intercambiabilità, indicano le modifiche introdotte in serie nel corso della produzione.

Sul retro di ogni tavola è riportato:

- Elenco dei complessivi illustrati nella tavola, con l'indicazione dei numeri di disegno dei particolari componenti.
- Elenco dei particolari modificati, con l'indicazione dei dati matricolari del veicolo, a partire dal quale è stata introdotta in serie la modifica.  
I particolari non più montati a causa di modifiche introdotte, però ugualmente forniti per ricambi perchè interessano i veicoli pre-modifica, saranno contrassegnati con la sigla « Ab. »; quelli aggiunti con la sigla « Agg. ».
- Eventuali note.

## N O T I C E

This catalogue consists of 18 tables, on which are listed all the details furnished as spares for the Vespa 150 with prefixes VB 1 produced in 1957.

Details and drg. numbers printed in red on the tables, and with the sign +, denoting not interchangeable, indicate the modifications introduced in series during production.

There is on the back of each table:

- List of assemblies illustrated on the tables, with drg. numbers of individual component parts.
- List of details modified, with vehicle serial number corresponding to that when the modification was introduced in production.  
Parts no longer mounted following the introduction of modifications, but still furnished as spares in so much as they are of interest to pre-modified vehicles, will be marked by the abbreviations « Ab. »  
Parts added will be marked « Agg. ».
- Notes.



INDICE DELLE TAVOLE — INDEX OF TABLES

1° Gruppo: MOTORE  
1st Group: ENGINE

Carter - Cilindro  
Crankcase - Cylinder

T. I

Albero motore - Frizione  
Crankshaft - Clutch

T. II

Ingranaggi cambio - Leva avviamento  
Gear box - Kickstarter

T. III

Volano magnete - Ventilatore  
Flywheel magneto - Fan

T. IV

Carburatore - Filtro aria - Settore cambio - Bobina A. T.  
Carburettor - Air cleaner - Gear shifter - Ignition coil

T. V

Serbatoio - Sella  
Fuel tank - Saddle

T. VI

Telaio - Sacca porta attrezzi - Cofano motore  
Chassis - Tool box - Engine bonnet

T. VII

2° Gruppo: SCOCCA  
2nd Group: CHASSIS

Traverse per motore - Sospensione poster. - Ammortizzatore poster.  
Engine bracket - Rear suspension - Rear damper

T. VIII

Strisce - Cavalletto - Marmitta  
Channels - Center stand - Silencer

T. IX

scooterhelp.com



## INDICE DELLE TAVOLE — INDEX OF TABLES

<p>3° Gruppo: STERZO 3rd Group: STEERING COLUMN</p>	}	<p>Parafango - Mozzo ruota anteriore Mudguard - Front wheel hub</p>	<p>T. X</p>
		<p>Ammortizzatore anteriore - Sospensione anteriore - Antifurto Front damper - Front suspension - Security lock</p>	<p>T. XI</p>
<p>4° Gruppo: MANUBRIO 4th Group: HANDLEBARS</p>	}	<p>Manubrio - Comandi - Contachilometri Handlebars - Controls - Speedometer</p>	<p>T. XII</p>
		<p>Trasmissioni - Pedale freno posteriore Control cables - Rear brake pedal</p>	<p>T. XIII</p>
<p>5° Gruppo: RUOTA 5th Group: WHEEL</p>		<p>Cerchione - Pneumatico Rim - Tyre</p>	<p>T. XIV</p>
<p>6° Gruppo: IMPIANTO ELETTRICO 6th Group: ELECTR. EQUIPMENT</p>	}	<p>Faro ant. - Fanalino post. - Clacson - Commutatore - Batteria Head lamp - Tail lamp - Horn - Switch - Battery</p>	<p>T. XV</p>
		<p>Connessioni elettriche Cable harness</p>	<p>T. XVI</p>
<p>7° Gruppo: ACCESSORI 7th Group: ACCESSORIES</p>		<p>Ruota di scorta - Sella posteriore Spare wheel - Rear saddle</p>	<p>T. XVII</p>
<p>8° Gruppo: ATTREZZI DI CORREDO 8th Group: TOOL KIT</p>		<p>Borsa attrezzi Hand tools</p>	<p>T. XVIII</p>

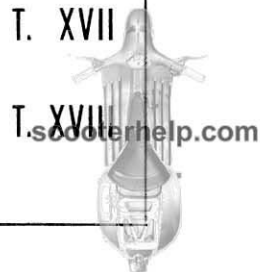

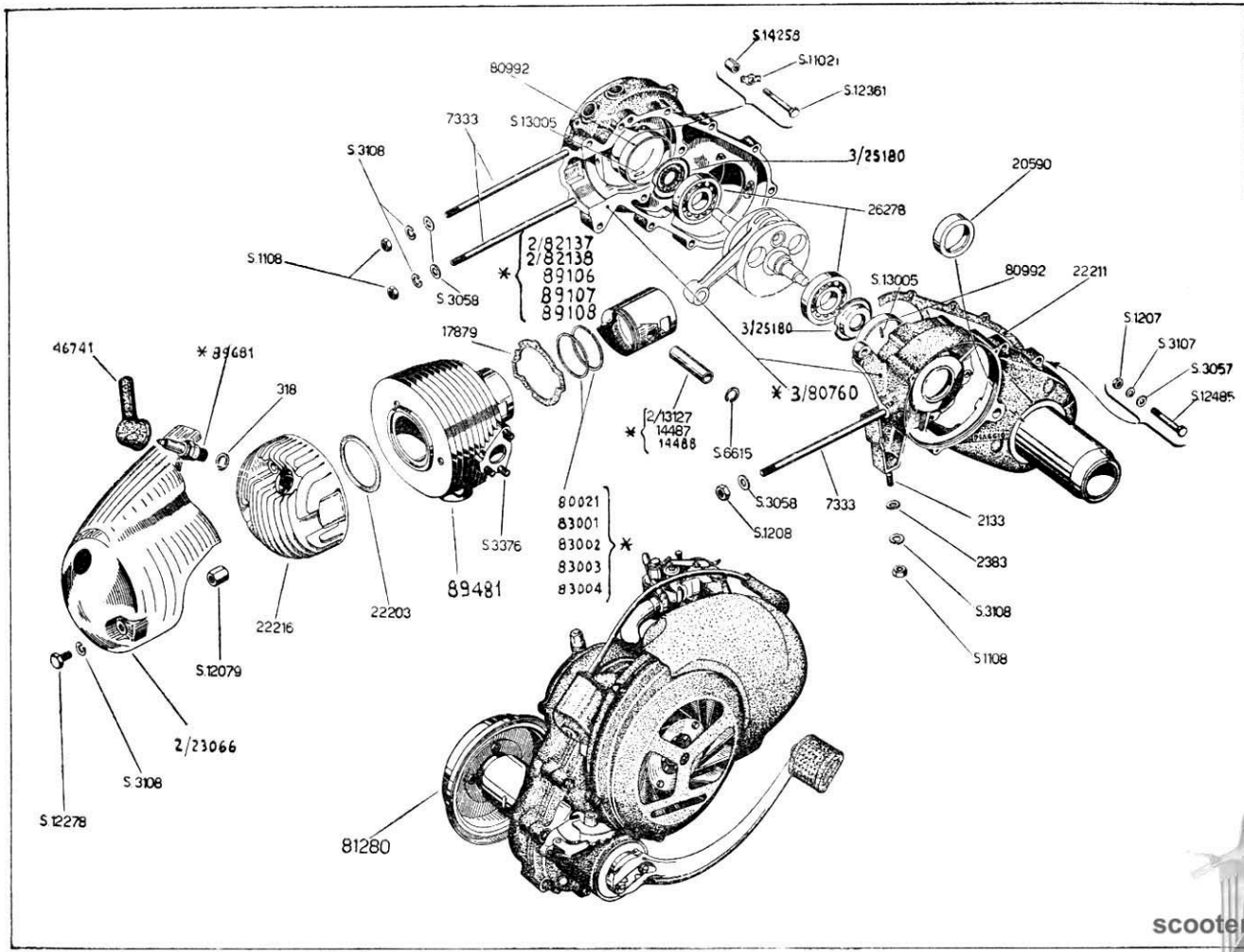

Carter - Cilindro  
Crankcase - Cylinder

1° Gruppo: MOTORE  
1.1 Group: ENGINE

scooterhelp.com



Vedere retro — P.T.O.

# T. I

## Indice dei complessivi — Index of assemblies

Numero Number	Particolari componenti il gruppo Constituent group details	Numero Number	Particolari componenti il gruppo Constituent group details
<b>3/80760</b>	(con/with 2133 - 7333 - 20590 - 22211 - 22387 - 80992 - S.1207 - S.3057 - S.3107 - S.11021 - S.12361 - S.12485 - S.14258)	<b>2/82138</b>	(con/with 2/13127 - S.6615)
<b>81280</b>	(T. I - II - III - IV - V)	<b>89106</b>	(con/with 2/13127 - S.6615)
<b>2/82137</b>	(con/with 2/13127 - S.6615)	<b>89107</b>	(con/with 2/13127 - S.6615)
		<b>89108</b>	(con/with 2/13127 - S.6615)
		<b>89481</b>	(con/with S.3376)

### NOTE — NOTES

- \* 3/80760 carter - deve essere montato abbinato alla bussola 20590 (Tav. I), al tubo 80429 (Tav. II) e al cuscinetto 7563 (Tav. II).  
**N. B.** - I semicartermi separati non si forniscono come p. r. - Dovendosi sostituire un semicarter inviare in Stabilimento l'altro semicarter ancora utilizzabile per l'accoppiamento col nuovo.

The crankcase No. 3/80760 should be assembled with the bush 20590 (Tab. I), the tube 80429 (Tab. II) and the bearing 7563 (Tab. II).

**N. B.** - When replacing crankcase halves (see our circular 48 T. I., Feb.22.57) order parts "b" (flywheel side) and "c" (clutch side) depending on crankcase g. a. (see "a"). a: 3/80760; b: 24974; c: 80428.

- \* 2/82137 - Gruppo pistone-spinotto normale — Piston-wrist pin group, normal  
 2/82138 - Gruppo pistone-spinotto 1.a magg. — Piston-wrist pin group, 1st o/s  
 89106 - Gruppo pistone-spinotto 2.a magg. — Piston-wrist pin group, 2nd o/s  
 89107 - Gruppo pistone-spinotto 3.a magg. — Piston-wrist pin group, 3rd o/s  
 89108 - Gruppo pistone-spinotto 4.a magg. — Piston-wrist pin group, 4th o/s
- \* 80021 - Anello normale — Spacer ring, normal  
 83001 - Anello 1.a magg. — Spacer ring, 1st o/s  
 83002 - Anello 2.a magg. — Spacer ring, 2nd o/s  
 83003 - Anello 3.a magg. — Spacer ring, 3rd o/s  
 83004 - Anello 4.a magg. — Spacer ring, 4th o/s
- \* 2/13127 - Spinotto normale — Wrist pin, normal dia.  
 14487 - Spinotto 1.a magg. — Wrist pin, 1st o/s.  
 14488 - Spinotto 2.a magg. — Wrist pin 2nd o/s.
- \* Oltre alla candela Marelli CW 225 NT (disegno 89681) possono essere montate le sottoindicate candele:  
 AC 43 F - AC 43 L - CHAMPION L 86 - BOSCH W 225 T. I. - K.L.G. F 70 - K.L.G. F 75.  
 Apart from the sparkplug Marelli CW 225 NT (drg. 89681), the following plugs can be mounted:  
 AC 43 F - AC 43 L - CHAMPION L 86 - BOSCH W 225 T. I. - K.L.G. F 70 - K.L.G. F 75.



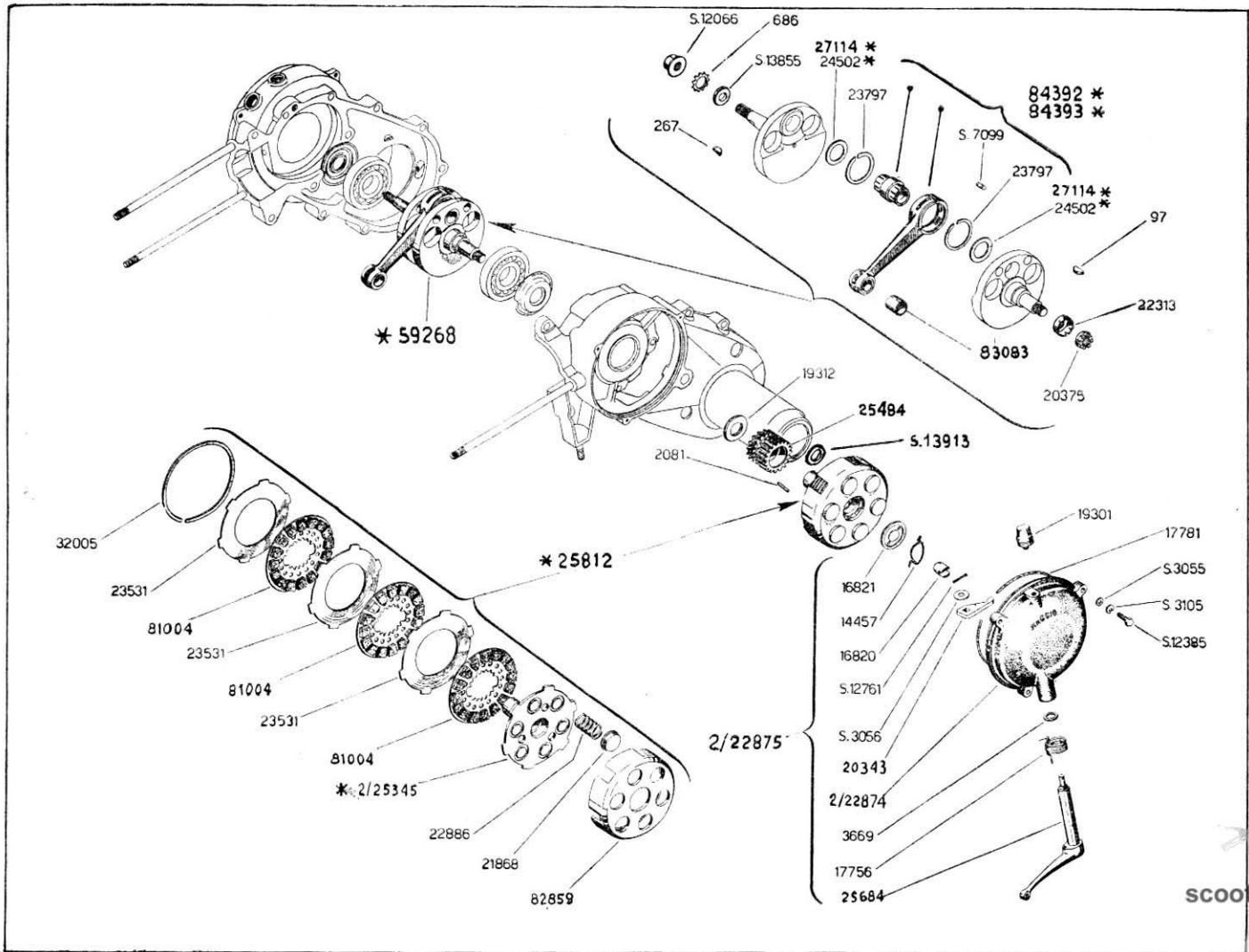

Albero motore - Frizione  
Crankshaft - Clutch

1° Gruppo: MOTORE  
1st Group: ENGINE

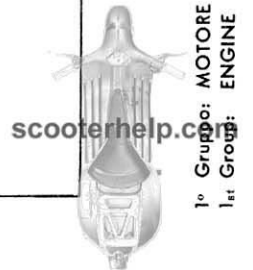

Vedere retro — P. T. O.

## T. II

## Indice dei complessivi — Index of assemblies

Numero Number	Particolari componenti il gruppo Constituent group details	Numero Number	Particolari componenti il gruppo Constituent group details
2/22875	(3669 - 16820 - 17756 - 19301 - 20343 - 2/22874 25684 - S.3056 - S.12761)	59268	Albero motore completo - Crankshaft (circ. 167. T. I.)
25812	(21868 - 22886 - 23531 - 2/25345 - 32005 - 81004 - 82859)	84392	(con/with 23797 - 27114 - 83083 - S.7099)
		84393	(con/with 23797 - 24502 - 83083 - S.7099)

## NOTE — NOTES

- \* La frizione 25812 e il boccolo 2/25345 devono essere sempre montati con l'ingranaggio motore 25484 provvisto dei 4 fori per la lubrificazione, interponendo la rondella S.13913.  
The clutch 25812 and flange 2/25345 must always be mounted with the drilled pinion (4 lubricating holes) 25484, interposing the washer S.13913.
- \* I gruppi biella - bottone indicati sulla tavola non valgono per l'albero 59268 (con gabbia a rulli) ma per i pre-modifica (a rulli giuntivi) montati sui veicoli.  
The groups con-rod crank pin indicated on the table are not valid for the crankshaft 59268 (with roller cage) but for those pre-modified (with loose rollers) mounted on vehicles.
- \* 84392 - Gruppo biella - Bottone di manovella.  
Per alberi motore aventi semialberi di spessore 10.5 mm. in corrispondenza della sede del bottone, e bottone privo di gole.  
84393 - Gruppo biella - Bottone di manovella.  
Per alberi motore aventi semialberi di spessore 11 mm. in corrispondenza della sede del bottone e bottone munito di gole.  
84392 - Group con-rod - crank pin.  
For crankshaft with half shafts having a thickness de 10,5 mm. (0.413 mm) in correspondance to the crankpin seating and crankpins without undercut.  
84393 - Group con.rod - crank pin.  
For crankshaft with half shafts having a thickness of 11 mm. (0.433) in correspondance to the crank pin seating and crank pin with undercut.

scooterhelp.com





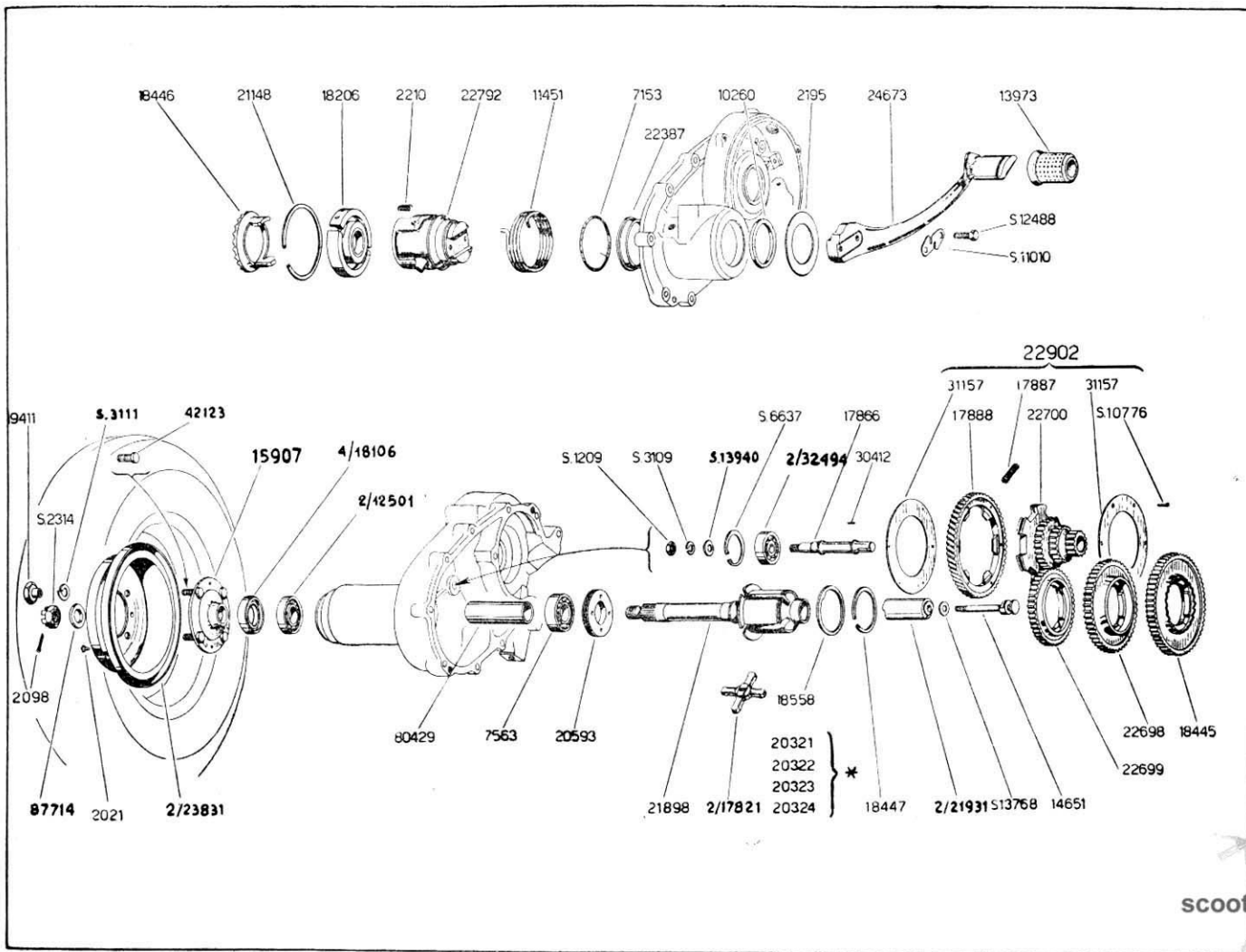

Ingranaggi cambio - Leva avviamento  
Gear box - Kickstarter

1° Gruppo: MOTORE  
1st Group: ENGINE



scooterhelp.com

Vedere retro — P. T. O.

## T. III

## Indice dei complessivi — Index of assemblies

Numero Number	Particolari componenti il gruppo Constituent group details	Numero Number	Particolari componenti il gruppo Constituent group details
15907	(con/with 42123)	22902	(17887 - 17888 - 22700 - 31157 - S.10776)

## NOTE — NOTES

- \* 20321 - Anello 1.a magg. — Spacer washer 1st o/s  
 20322 - Anello 2.a magg. — Spacer washer 2nd o/s  
 20323 - Anello 3.a magg. — Spacer washer 3rd o/s  
 20324 - Anello 4.a magg. — Spacer washer 4th o/s



## T. IV

## Indice dei complessivi — Index of assemblies

Numero Number	Particolari componenti il gruppo Constituent group details	Numero Number	Particolari componenti il gruppo Constituent group details
<b>16414</b>	(con/with 16417)	<b>22703</b>	(603 - 622 - 624 - 625 - 3213 - 16414 - 16416 - 16418 - 16419 - 16420 - 16421 - 18941 - 20842 - 20843 - 22096 - 22097 - 22098 - 23361 - S. 3055 - S. 3103 - S. 3105 - S. 12331 - S. 12332 - S. 13800 - S. 13801)
<b>18941</b>	(con/with 14501)		
<b>20842</b>	(con/with 662 - 14501)		
<b>20843</b>	(con/with 662 - 14501)		
<b>22541</b>	(con/with 6562 - 16412 - S. 10775)	<b>22711</b>	(22541 - 22703)
		<b>23361</b>	(con/with 662 - 14501)



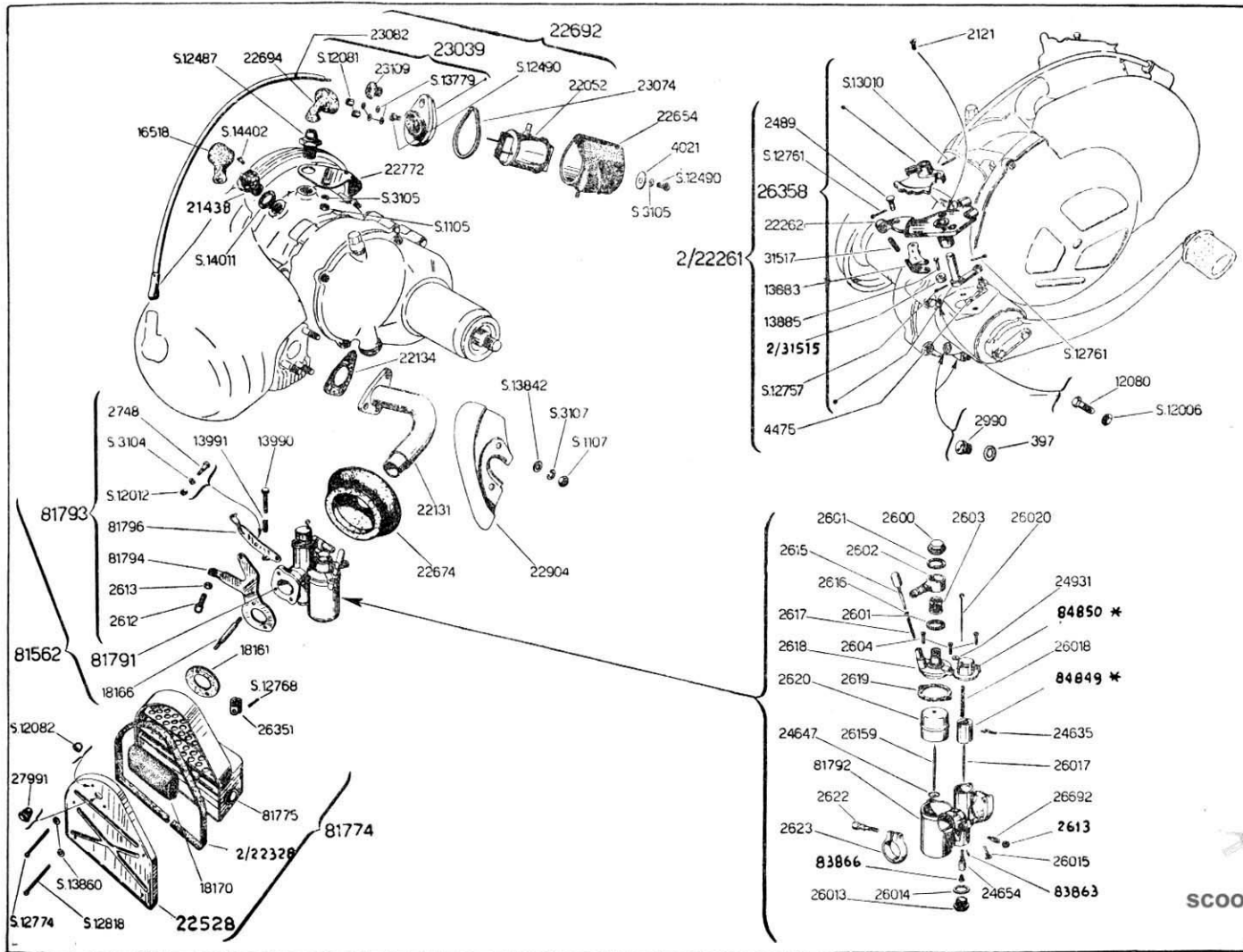

Carburatore - Filtro aria - Settore cambio - Bobine A. T.  
 Carburettor - Air cleaner - Gear shifter - Ignition coil

1° Gruppo: MOTORE  
 1st Group: ENGINE

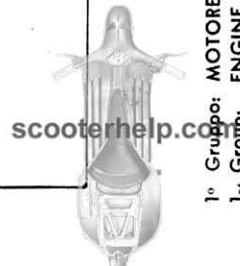

Vedere retro — P. T. O.

Numero Number	Particolari componenti il gruppo Constituent group details	Numero Number	Particolari componenti il gruppo Constituent group details
2/22261	(2489 - 4475 - 13883 - 13885 - 22262 - 26358 - 2/31515 - 31517 - S.12757 - S.12761)	81774	(18170 - 2/22328 - 22528 - 26351 - 81775 - S.12768 S.12774 - S.12818 - S.13860)
22528	(con/with 27991)	81791	(2600 - 2601 - 2602 - 2603 - 2604 - 2613 - 2615 - 2616 - 2617 - 2618 - 2619 - 2620 - 2622 - 2623 - 24635 - 24654 - 24931 - 26013 - 26014 - 26015 - 26017 - 26018 - 26020 - 26159 - 26692 - 81792 - 83863 - 83866 - 84849 - 84850)
22692	(22052 - 23039 - 23082 - S.12490)	81793	(2612 - 2613 - 2748 - 13990 - 13991 - 81794 - 81796 S.3104 - S.12012)
23039	(con/with 23109 - S.12081 - S.13779)		
26358	(con/with S.13010)		
81562	(18166 - 81791 - 81793)		

## NOTE — NOTES

- \* 84850 coperchio - 84849 valvola - Devono essere montati abbinati.  
The cover 84850 and the valve 84849 must be mounted together.



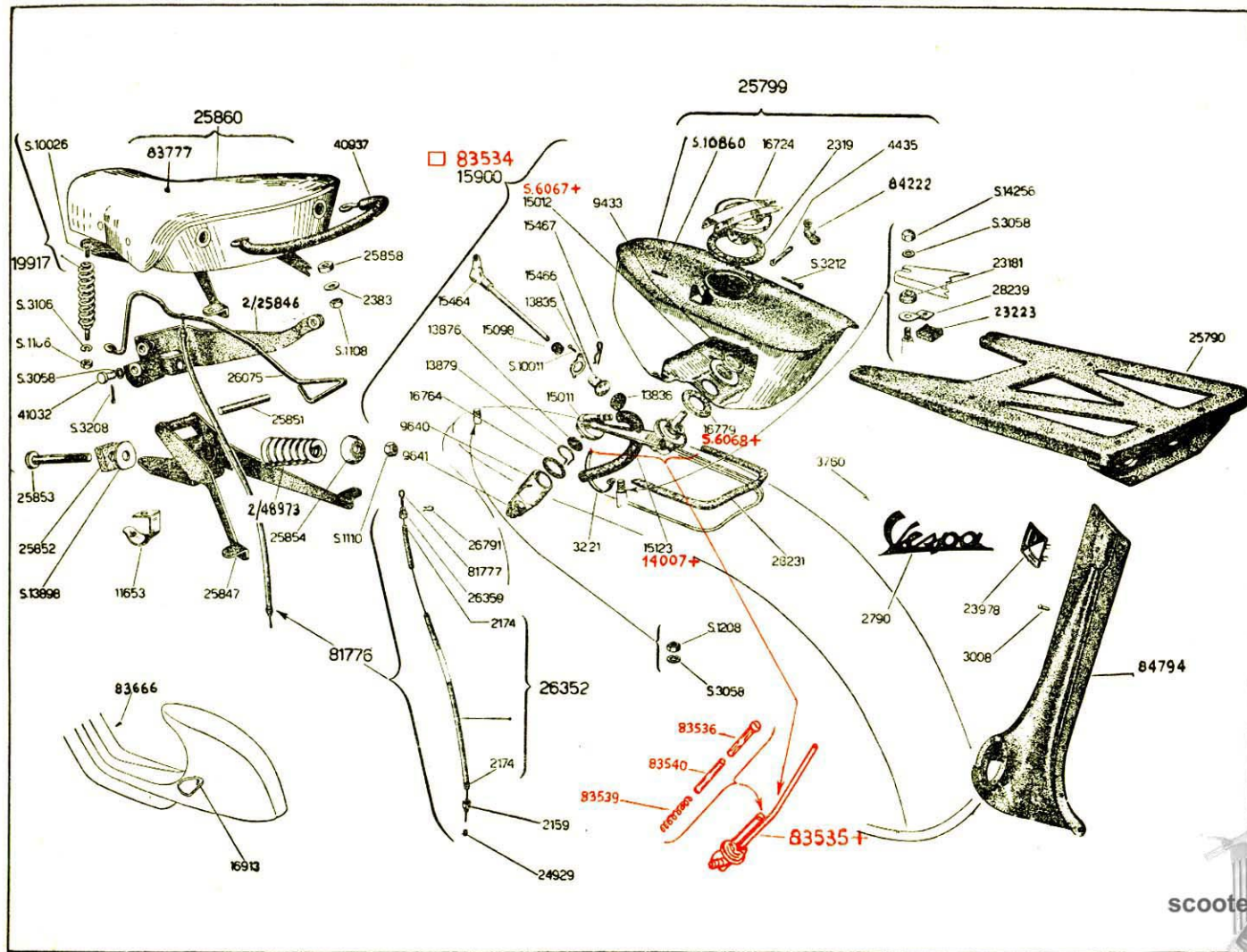

Seratoio - Sella  
Fuel tank - Saddle

Gruppo: SCOCCA  
2<sup>nd</sup> Group: CHASSIS

scooterhelp.com



Vedere retro — P. T. O.

# T. VI

## Indice dei complessivi — Index of assemblies

Numero Number	Particolari componenti il gruppo Constituent group details	Numero Number	Particolari componenti il gruppo Constituent group details
15900	(9433 - 9640 - 9641 - 13835 - 13836 - 13876 - 13879 - 15011 - 15012 - 15464 - 15466 - 15467 - 16764 - 16779 - S.10011)	25860	(con/with 2383 - 19917 - 2/25846 - 25847 - 25851 - 25852 - 25853 - 25854 - 25858 - 40937 - 41032 - 2/48973 - S.1106 - S.1108 - S.1110 - S.3058 - S.3106 - S.3208 - S.13898)
19917	(con/with S.10026)	26352	(con/with 2174)
25799	(con/with 2319 - 4435 - 16724 - 84222 - S.3212 - S.10860)	81776	(con/with 2159 - 24929 - 26352 - 26359 - 81777)

## Indice dei partic. modificati — Index of parts modified

Numero pre-modifica No. before mod.	Quantità No. off	Numero post-modifica New number	Prefisso d'introduzione telaio Chassis introduction prefix	Numero pre-modifica No. before mod.	Quantità No. off	Numero post-modifica New number	Prefisso d'introduzione telaio Chassis introduction prefix
15011	1	+ 83535 (con/with 83536 - 83539 - 83540)	VB 1 - 61421	16779	1	+ S.6068	VB 1 - 61421
15012	1	+ S.6067	VB 1 - 61421	Agg.	1	83536	VB 1 - 61421
15123	1	+ 14007	VB 1 - 61421	Agg.	1	83539	VB 1 - 61421
15900	1	■ 83534 (9433 - 13835 - 13836 - 15464 - 15466 - 15467 - 83535 - S.6067 - S.6068 - S.10011)	VB 1 - 61421	Agg.	1	83540	VB 1 - 61421



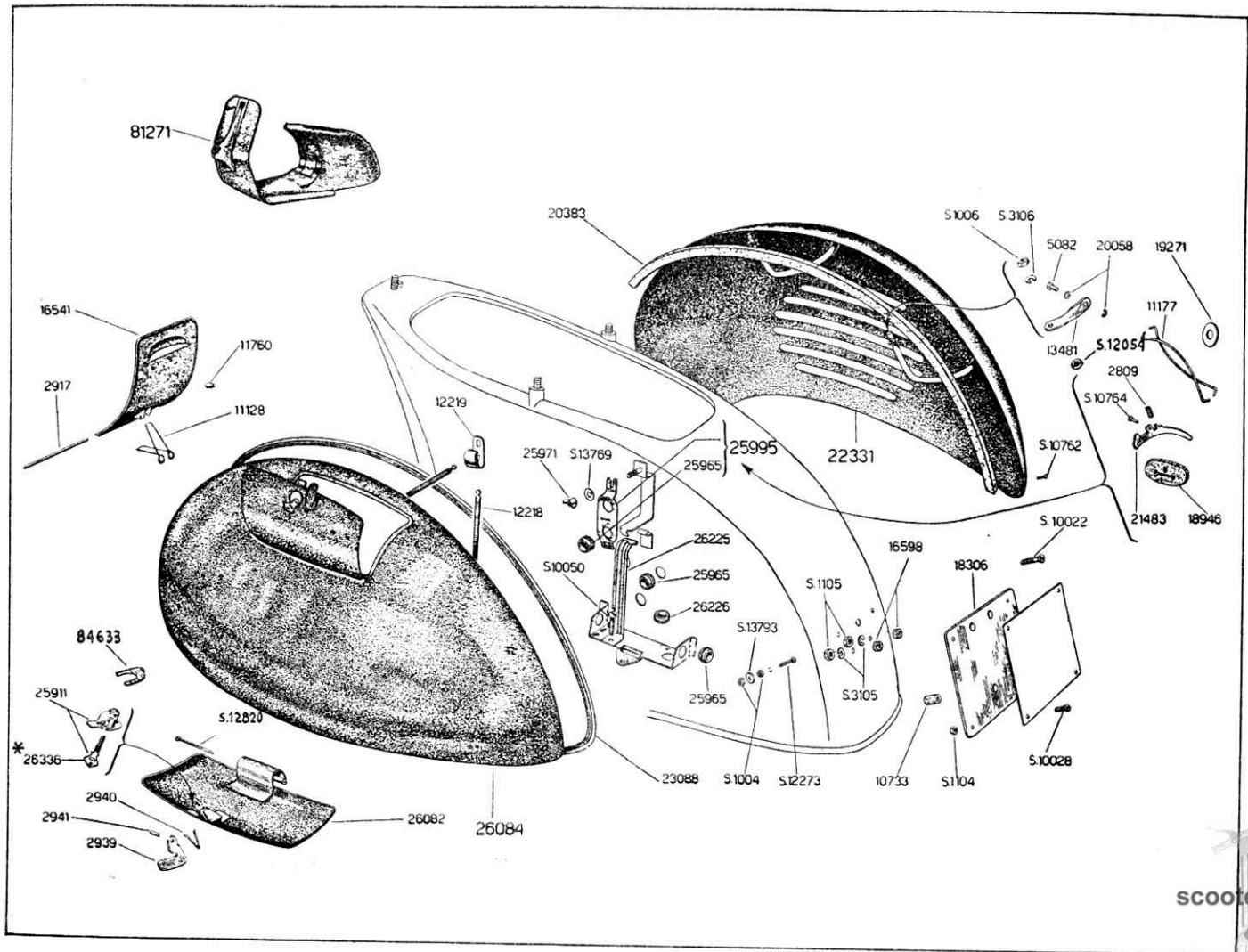

Telaio - Sacca porta attrezzi - Cofano motore  
 Chassis - Tool box - Engine bonnet

2° Gruppo: SCOCCA  
 2°nd Gruppo: CHASSIS

scooterhelp.com



Vedere retro — P. T. O.



# T. VII

## Indice dei complessivi — Index of assemblies

Numero Number	Particolari componenti il gruppo Constituent group details	Numero Number	Particolari componenti il gruppo Constituent group details
22331	(con/with 2809 - 21483 - S.10764)	81271	(con/with 2790 - 2917 - 3008 - 3760 - 5082 -
25995	(con/with 25965)		11128 - 11760 - 13481 - 16541 - 20058 - 23978 -
26084	(con/with 2939 - 2940 - 2941 - 25911 - 26082 - S.12820)		40292 - 40311 - 40315 - 2/40317 - 84794 - S.1209 S.12343 - S.13762)

### NOTE — NOTES

\* 26336 - Chiave - Per ricambi indicare: il numero 26336 ed il numero impresso sulla chiave.

On requesting the key 26336 besides indicating the drawing number, indicate also the number stamped on the key itself.



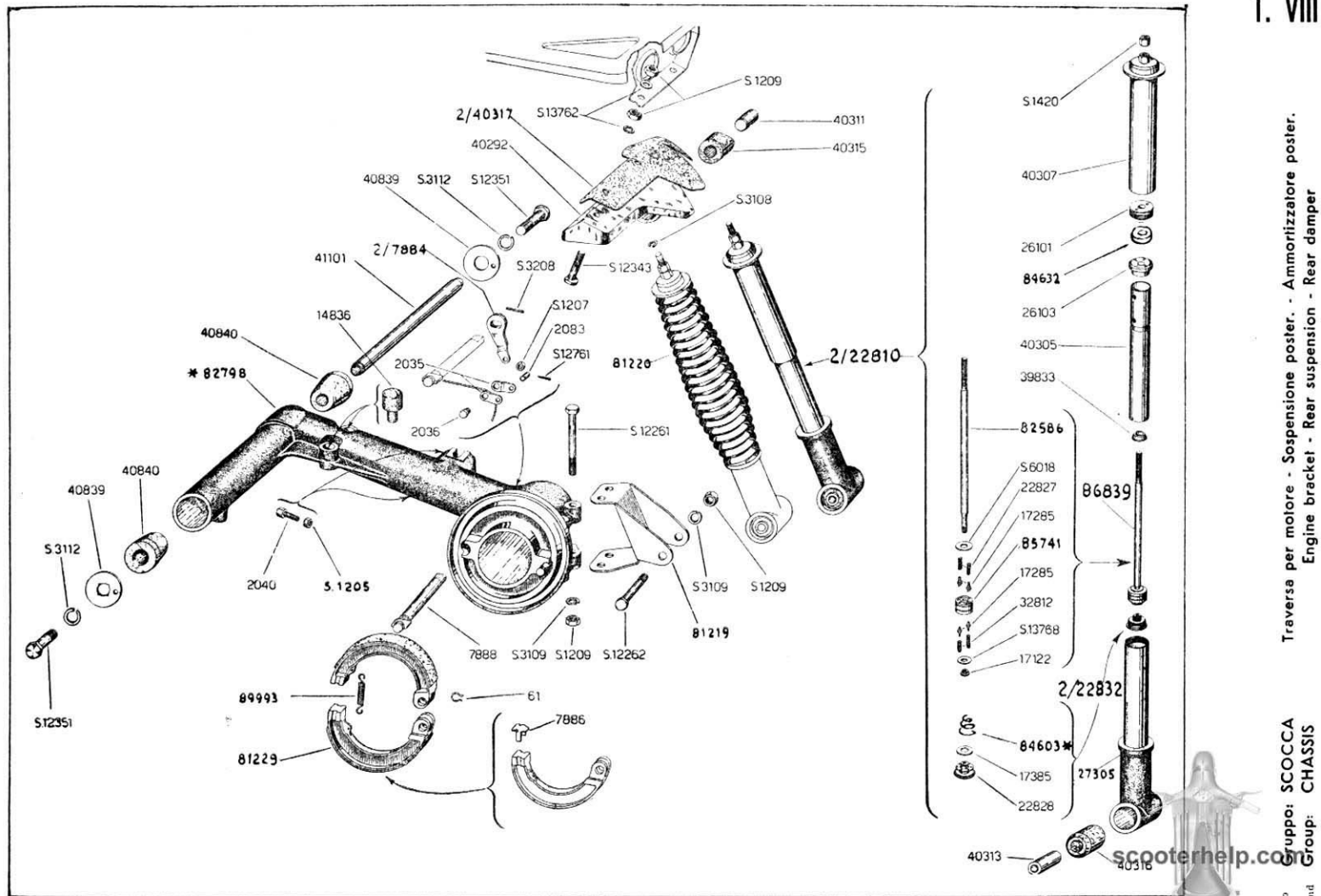

Traversa per motore - Sospensione poster. - Ammortizzatore poster.  
 Engine bracket - Rear suspension - Rear damper

Gruppo: SCOCCA  
 Group: CHASSIS

Vedere retro — P. T. O.



Numero Number	Particolari componenti il gruppo Constituent group details	Numero Number	Particolari componenti il gruppo Constituent group details
2/22810	(2/22832 - 26101 - 26103 - 27305 - 39833 - 40305 - 40307 - 40313 - 40316 - 84632 - 86839 - S. 1420)	86839	(17122 - 17285 - 22827 - 32812 - 82586 - 85741 - S. 6018 - S. 13768)
2/22832	(17385 - 22828 - 84603)		

## NOTE — NOTES

- \* La molla 84603 a catalogo può sostituire la pre-esistente abolendo l'anello montato all'estremità della valvola.  
The spring 84603 on the spares list can substitute that previously existing by annulling the ring mounted at the extremity of the valve.
- \* 82798 - Questa traversa si deve bloccare alla marmitta con dado S. 12092.  
82798 - This bracket should be blocked to the muffler with the nut S. 12092.



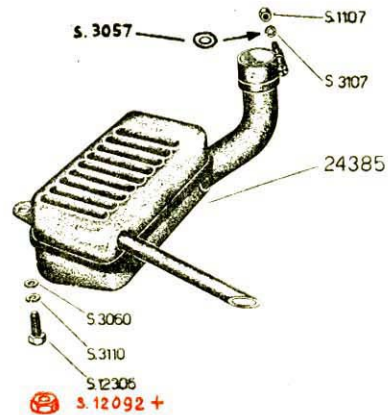
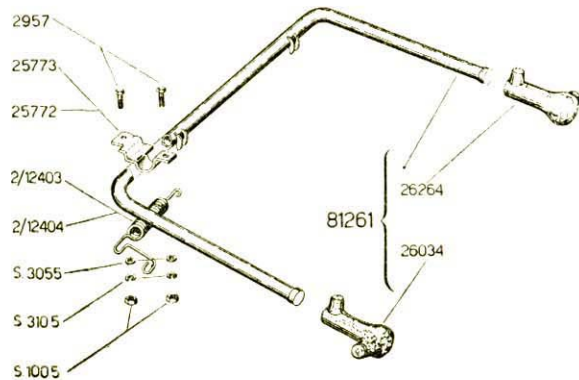
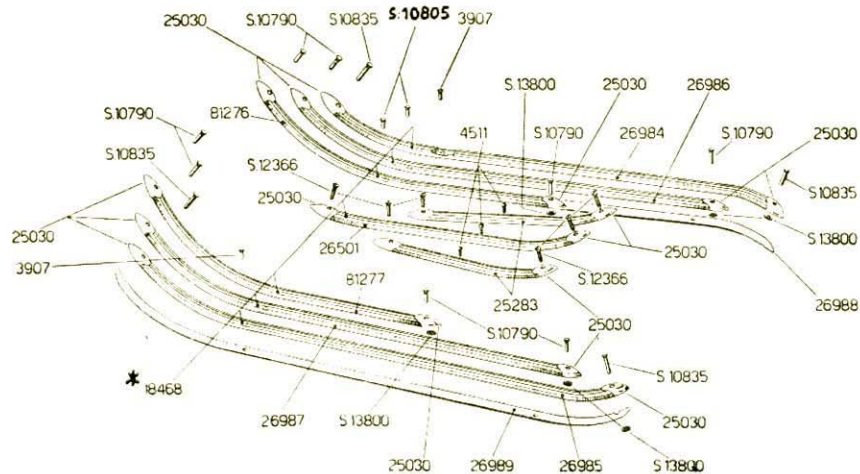

Siriscie - Cavalletto - Marmitta  
Channels - Center stand - Silencer

2° Gruppo: SCOCCA  
2° Gruppo: CHASSIS

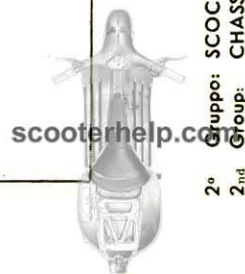

Vedere retro — P. T. O.

## T. IX

## Indice dei complessivi — Index of assemblies

Numero Number	Particolari componenti il gruppo Constituent group details	Numero Number	Particolari componenti il gruppo Constituent group details
24385	(con/with S. 1107 - S. 3057 - S. 3107)	81261	(con/with 26034 - 26264)

## NOTE — NOTES

- \* Il profilato 18468 deve essere richiesto in metri.  
The section 18468 should be requested in yards.
- \* 2/12403 - Molla destra - R. H. Spring
- 2/12404 - Molla sinistra - L. H. Spring

## Indice dei partic. modificati — Index of parts modified

Numero pre-modifica No. before mod.	Quantità No. off	Numero post-modifica New number	Prefisso d'introduzione telaio Chassis introduction prefix	Numero pre-modifica No. before mod.	Quantità No. off	Numero post-modifica New number	Prefisso d'introduzione telaio Chassis introduction prefix
S. 12306	1	+ S. 12092	61001				



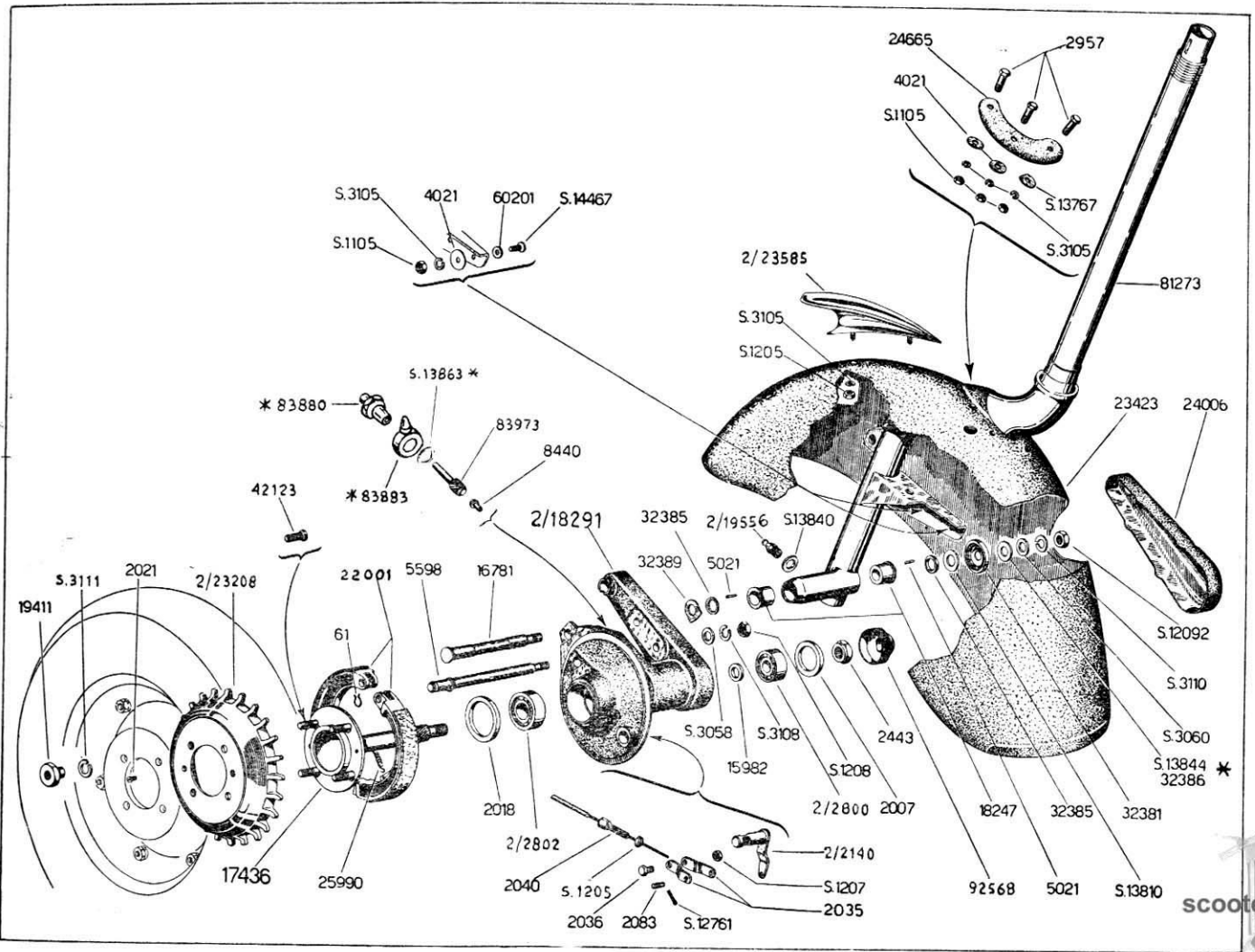

Parafango - Mozzo ruota anteriore  
Mudguard - Front wheel hub

3° Gruppo: STERZO  
3-rd Group: STEERING COLUMN

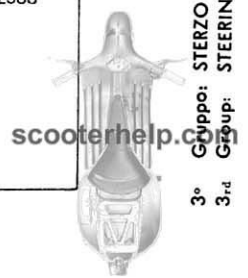

Vedere retro — P. T. O.

Numero Number	Particolari componenti il gruppo Constituent group details	Numero Number	Particolari componenti il gruppo Constituent group details
17436	(con/with 42123)	2/18291	(con/with 8440)

## NOTE — NOTES

- \* 83880 Sopperto - 83883 Anello - S. 13863 Rondella - Devono essere montati abbinati.  
The bracket 83880, ring 83883 and washer S. 13863 must be mounted together.
- \* 32386 - S. 13844 rondella - Con l'una o l'altra ottenere un giuco assiale di  $0,2 \div 0,4$  mm. sul perno dello sterzo.  
Mount the washer 32386 or S. 13844 depending on the thickness necessary to attain a play between steering column bush pin and hub, of  $0,2 \div 0,4$  mm.



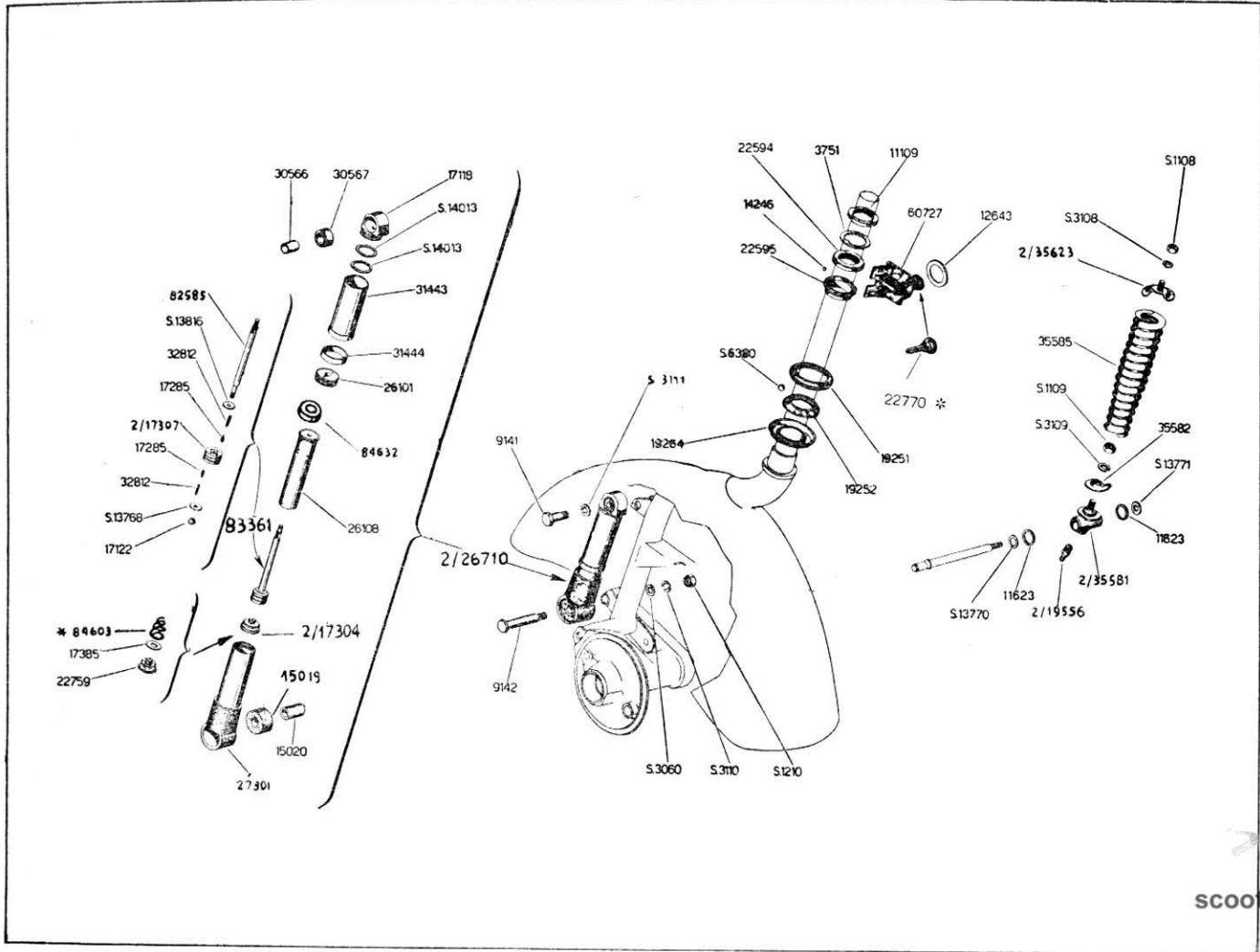

Ammortizzatore ant. - Sospensione ant. - Anfifurto  
 Front damper - Front suspension - Security lock

Gruppo: STERZO  
 Group: STEERING COLUMN

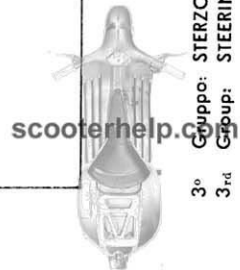

Vedere retro — P. T. O.



## T. XI

## Indice dei complessivi — Index of assemblies

Numero Number	Particolari componenti il gruppo Constituent group details	Numero Number	Particolari componenti il gruppo Constituent group details
2/17304 2/26710	(17385 - 22759 - 84603) (15019 - 15020 - 17118 - 2/17304 - 26101 - 26108 - 27301 - 30566 - 30567 - 31443 - 31444 - 83361 - 84632 - S. 14013)	83361	(17122 - 17285 - 2/17307 - 32812 - 82585 - S. 13768 S. 13816)

## NOTE — NOTES

- \* 22770 Chiave - Per ricambi indicare: Il numero 22770 ed il numero impresso sulla chiave.  
On requesting the key 22770 besides indicating the drawing number indicate also the number stamped on the key itself.
- \* La molla 84603 a catalogo può sostituire la pre-esistente abolendo l'anello montato all'estremità della valvola.  
The spring 84603 on the spares list can substitute that previously existing by annulling the ring mounted at the extremity of the valve.



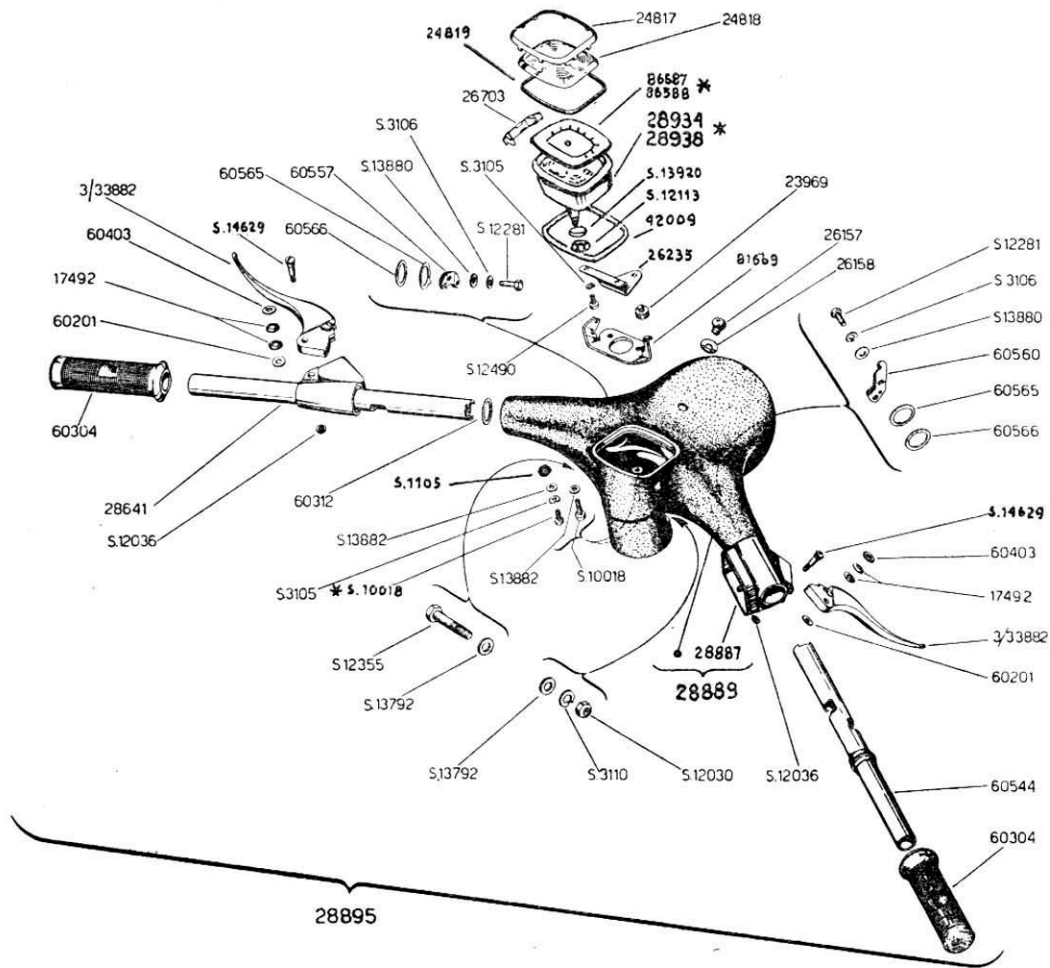

Manubrio - Comandi - Contachilometri  
 Handlebars - Controls - Speedometer

Gruppo: MANUBRIO  
 Gruppo: HANDLEBARS

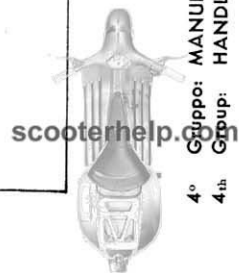

Vedere retro — P.T.O.

Numero Number	Particolari componenti il gruppo Constituent group details	Numero Number	Particolari componenti il gruppo Constituent group details
28889 28895	(con/with 28887) (17492 - 18699 - 23969 - 26157 - 26158 - 26235 - 28641 - 28889 - 3/33882 - 60201 - 60304 - 60312 - 60403 - 60544 - 60557 - 60560 - 60565 - 60566 - 81699 - S. 1105 - S. 3105 - S. 3106 - S. 3110 S. 10018 - S. 12030 - S. 12036 - S. 12281 - S. 12355 S. 13792 - S. 13880 - S. 13882 - S. 14629)	28934  28938	(con/with 24817 - 24818 - 24819 - 26703 - 86587 - S. 12113 - S. 13920) (con/with 24817 - 24818 - 24819 - 26703 - 86588 - S. 13920 - S. 12113)

## NOTE — NOTES

- \* 28934 Contachilometri - Speedometer in Klms.  
28938 Contamiglia - Speedometer in mls.
- \* 86587 Quadrante per contachilometri - Dial. for speedometer (Klms).  
86588 Quadrante per contamiglia - Dial for speedometer (mls).
- \* S.10018 vite - Dal progressivo anteriore a VB 1 T - 1453 montare la vite S.12490.  
S.10018 screw - On serial numbers prior to VB 1 T - 1453 mount the screw S.12490.



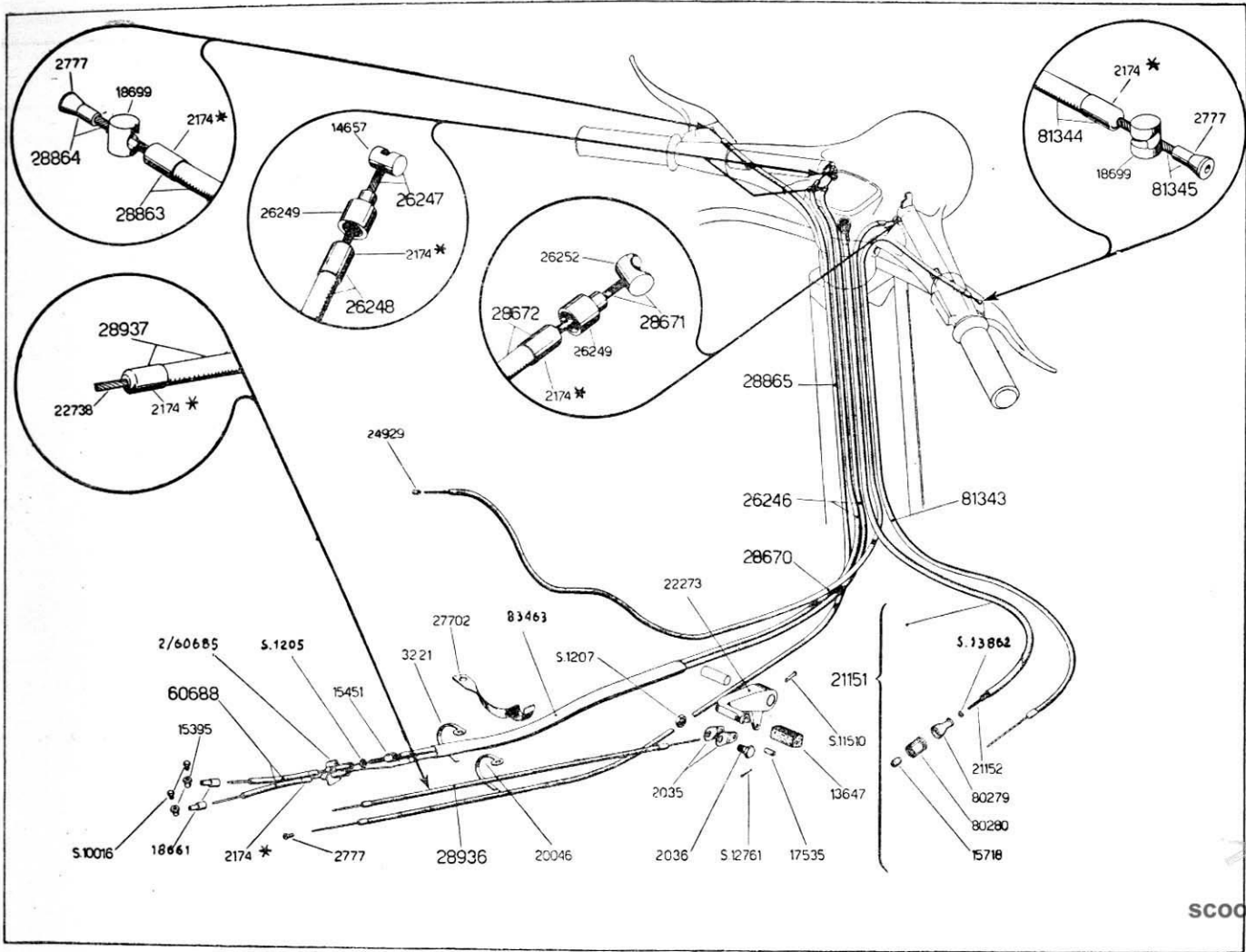

Trasmissioni - Pedale freno posteriore  
Control cables - Rear brake pedal

Gruppo: MANUBRIO  
Group: HANDLEBARS

scooterhelp.com



Vedere retro — P.T.O.

Numero Number	Particolari componenti il gruppo Constituent group details	Numero Number	Particolari componenti il gruppo Constituent group details
21151	(con/with 15718 - 21152 - 80279 - 80280)	28864	(con/with 2777)
26246	(26247 - 26248 - 26249)	28865	(2777 - 28863 - 28864)
26247	(con/with 14657)	28936	(22738 - 28937)
26248	(con/with 2174)	28937	(con/with 2174)
28670	(24929 - 26249 - 28671 - 28672)	60688	(con/with 2174)
28671	(con/with 26252)	81343	(81344 - 81345)
28672	(con/with 2174)	81344	(con/with 2174)
28863	(con/with 2174)	81345	(con/with 2777)

## NOTE — NOTES

- \* La protezione 2174 deve essere leggermente cianfrinata sulla guaina all'atto del montaggio.  
The protective cap 2174 must be lightly pinched onto the sheath on assembly.



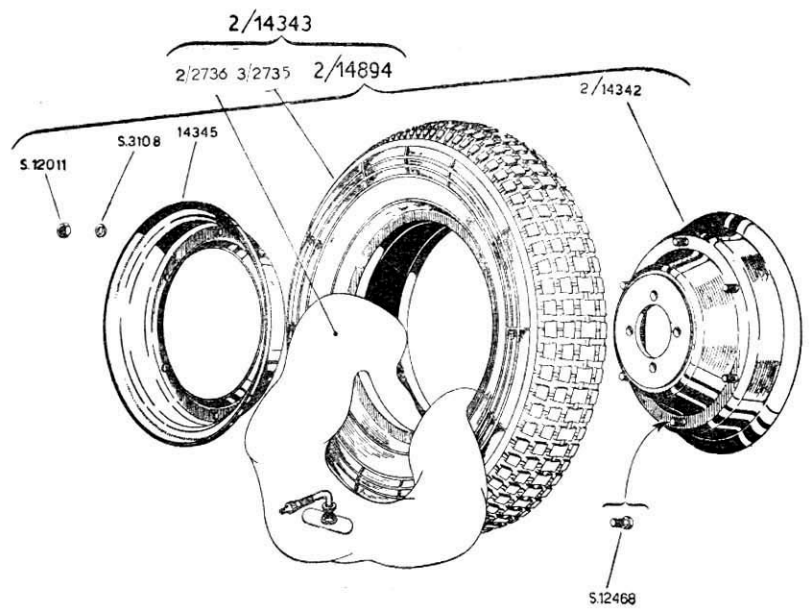

Cerchione - Pneumatico  
Rim - Tyre

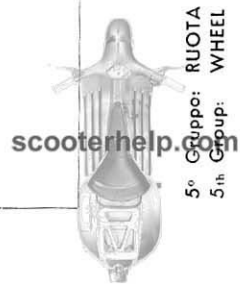

Vedere retro — P. T. O.

# T. XIV

## Indice dei complessivi — Index of assemblies

Numero Number	Particolari componenti il gruppo Constituent group details	Numero Number	Particolari componenti il gruppo Constituent group details
2/14342 2/14343	(con/with S.12468) (3/2735 - 2/2736 - 2/14894)	2/14894	(2/14342 - 14345 - S.3108 - S.12011)



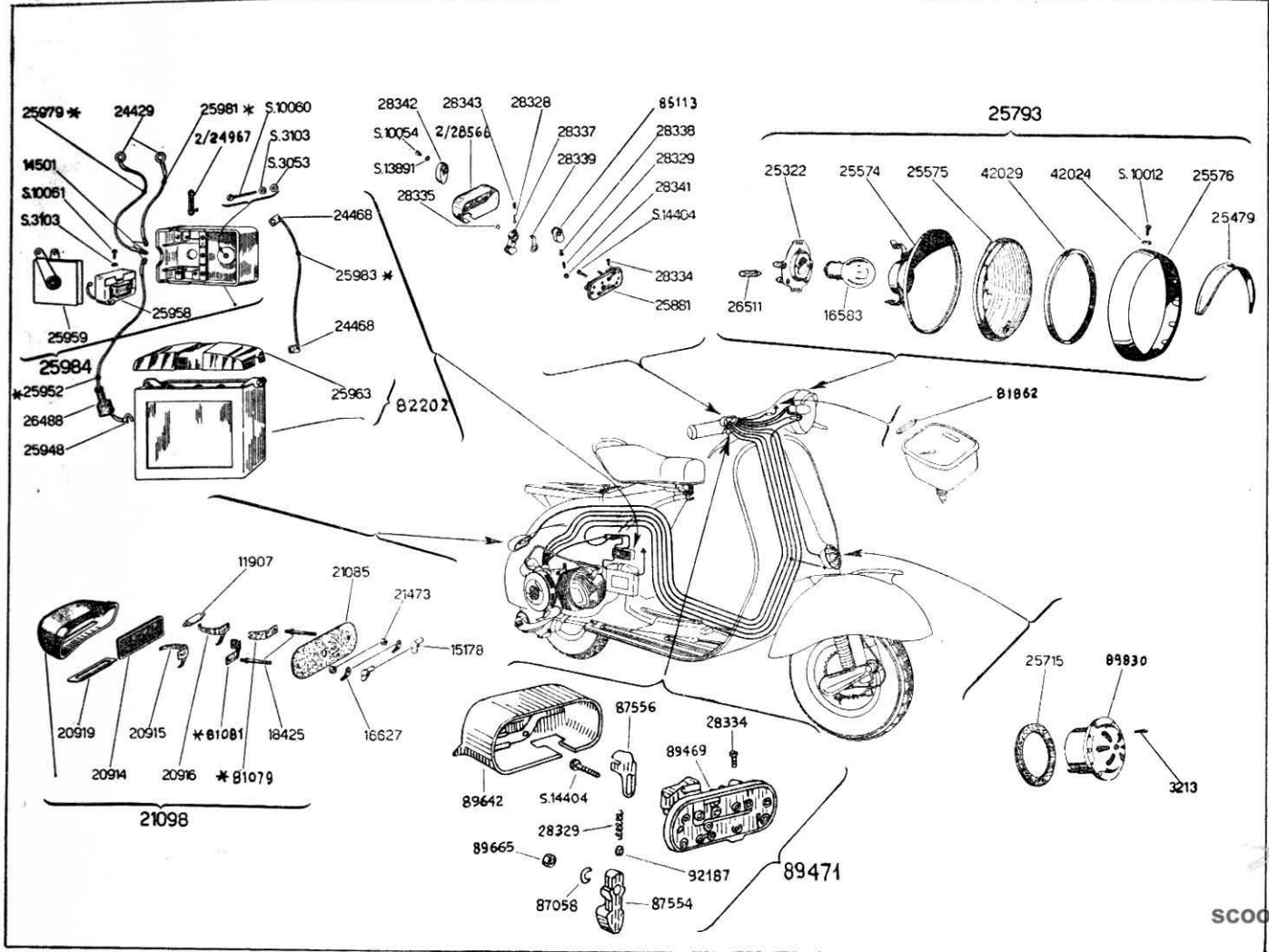

Faro ant. - Fanalino post. - Clacson - Commutatore - Batteria  
 Head lamp - Tail lamp - Horn - Switch - Battery

6° Gruppo: IMPIANTO ELETTRICO  
 6th Group: ELECTR. EQUIPMENT

scooterhelp.com



Vedere retro — P. T. O.



Numero Number	Particolari componenti il gruppo Constituent group details	Numero Number	Particolari componenti il gruppo Constituent group details
<b>21098</b>	(con/with 18425 - 20914 - 20915 - 20916 - 20919 - 81079 - 81081)	<b>82202</b>	(con/with 25963)
<b>25793</b>	(con/with 25322 - 25479 - 25574 - 25575 - 25576 - 42024 - 42029 - S.10012)	<b>89471</b>	(28329 - 28334 - 87058 - 87554 - 87556 - 89469 - 89642 - 89665 - 92187 - S.14404)
<b>25984</b>	(con/with 2/24967 - 25958 - 25959 - S.3053 - S.3103 - S.10060 - S.10061)		

## NOTE — NOTES

- \* 81079 - 81081 Mollette - devono essere montate abbinate.  
Retaining spring clips 81079 - 81081 - Must be mounted together.
- \* In luogo dei cavetti 25952 - 25979 - 25981 - 25983 richiedere in metri il cavetto 24582.  
In place of the wires 25952 - 25979 - 25981 - 25983 request the wire 24582.



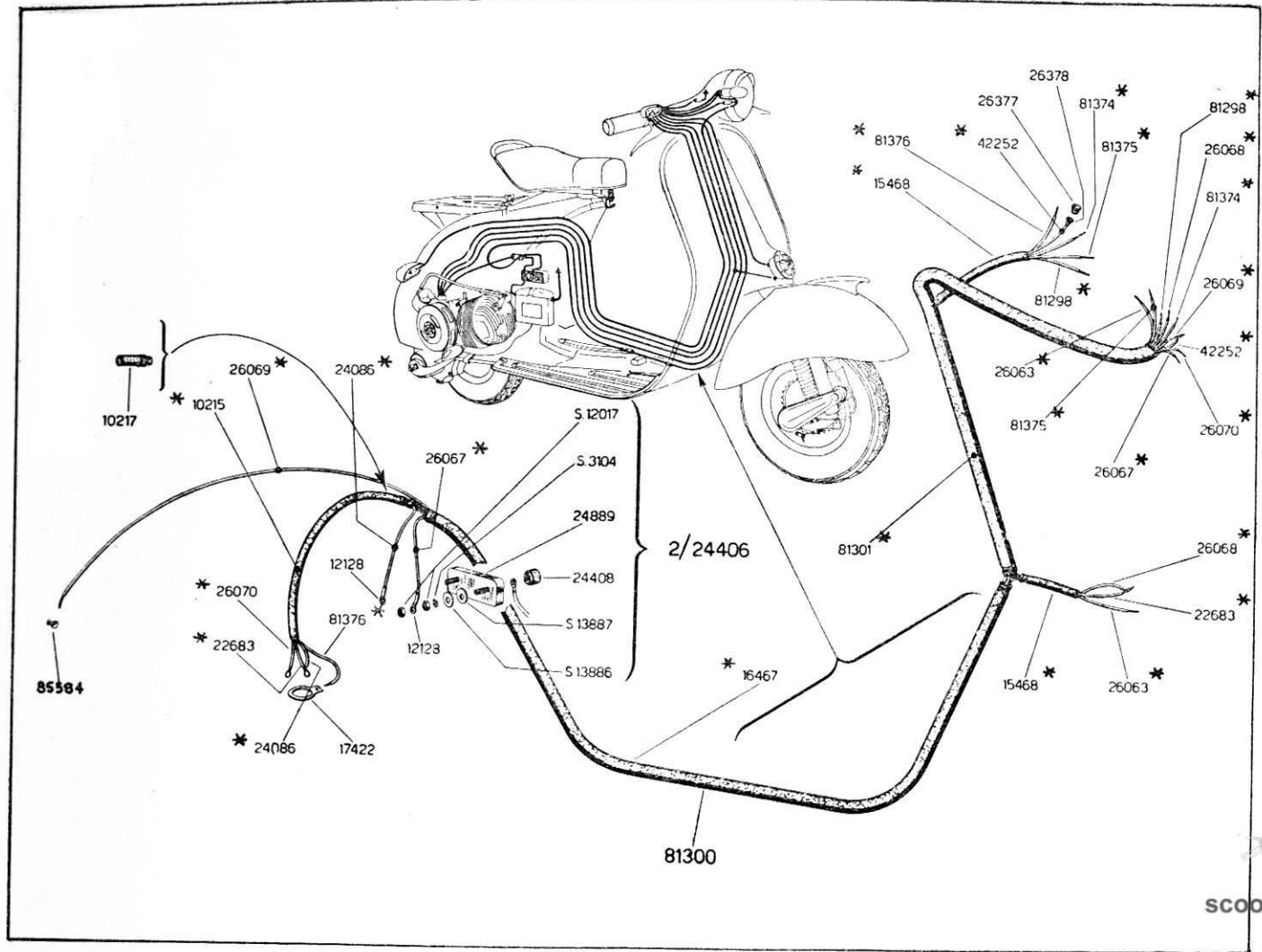

Connessioni elettriche  
Cable harness

6° Gruppo: IMPIANTO ELETTRICO  
6th Group: ELECTR. EQUIPMENT

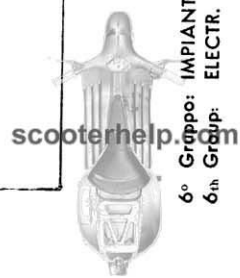

Vedere retro — P. T. O.

Numero Number	Particolari componenti il gruppo Constituent group details	Numero Number	Particolari componenti il gruppo Constituent group details
2/24406	(24408 - 24889 - S. 3104 - S. 12017 - S. 13886 - S. 13887)	81300	(10215 - 12128 - 15468 - 16467 - 17422 - 22683 - 24086 - 26063 - 26067 - 26068 - 26069 - 26070 - 26377 - 26378 - 42252 - 81298 - 81301 - 81374 - 81375 - 81376)

## NOTE — NOTES

\* In luogo dei cavetti 22683 - 24086 - 26063 - 26067 - 26068 - 26069 - 26070 - 42252 - 81298 - 81374 - 81375 - 81376 richiedere in metri il cavetto 24577.

In place of the wires 22683 - 24086 - 26063 - 26067 - 26068 - 26069 - 26070 - 42252 - 81298 - 81374 - 81375 - 81376 request the wire 24577 in yards.

\* Tubetto isolante      { 10215 - 87396 } Tubetto corrispondente da richiedere in metri.  
 Insulating tubes      { 15468 - 87394 }  
                                   { 16467 - 87400 } Corresponding tubes to request in feet or yards.  
                                   { 81301 - 87404 }



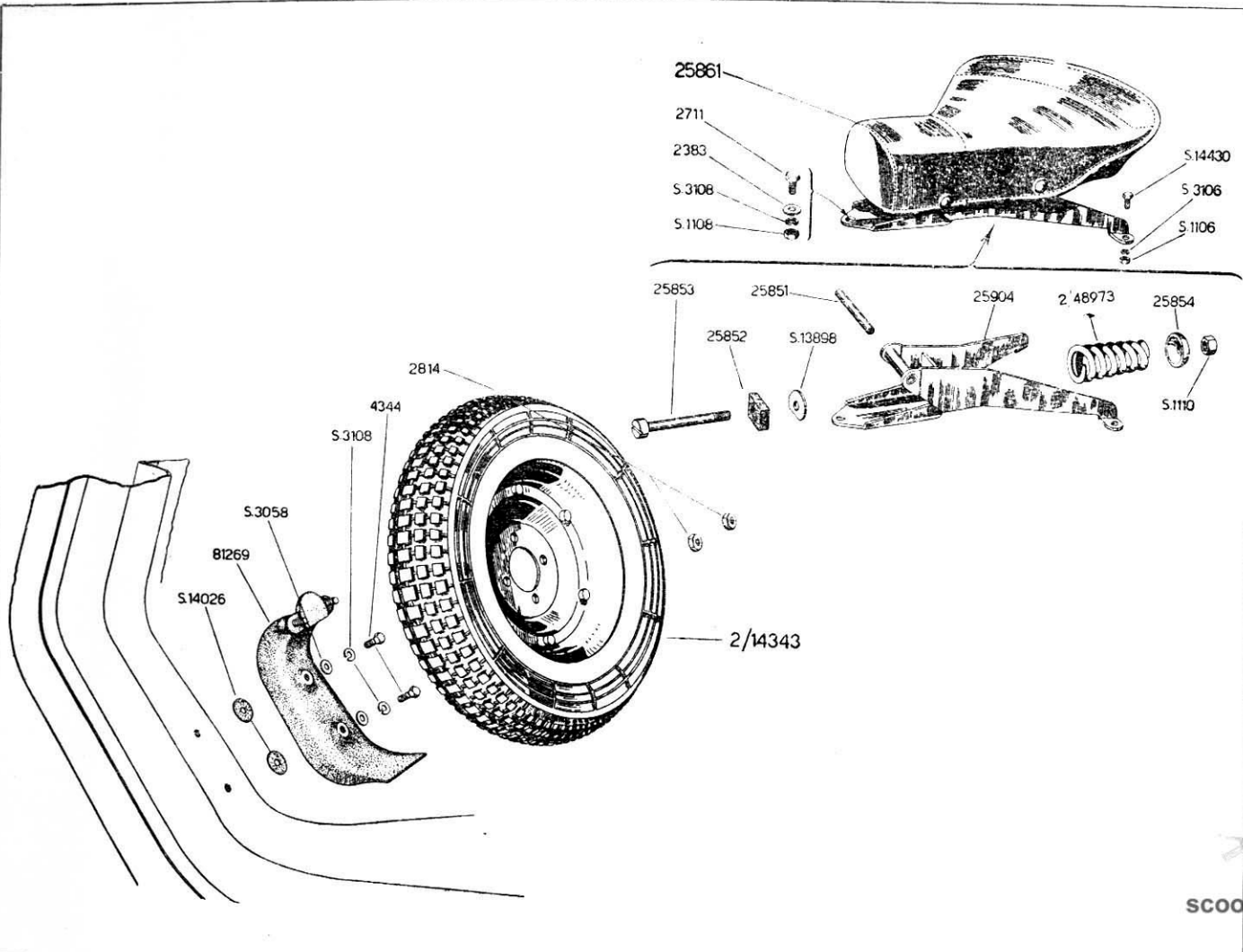

Ruota di scorta - Sella posteriore  
Spare wheel - Rear saddle

Vedere retro — P. T. O.

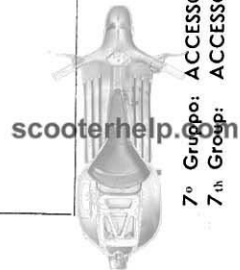

7° Gruppo: ACCESSORI  
7<sup>th</sup> Group: ACCESSORIES

Numero Number	Particolari componenti il gruppo Constituent group details	Numero Number	Particolari componenti il gruppo Constituent group details
2/14343	Ruota completa - Wheel assy.	25861	(con/with 25851 - 25852 - 25853 - 25854 - 25904 - 2/48973 - S.1110 - S.13898)



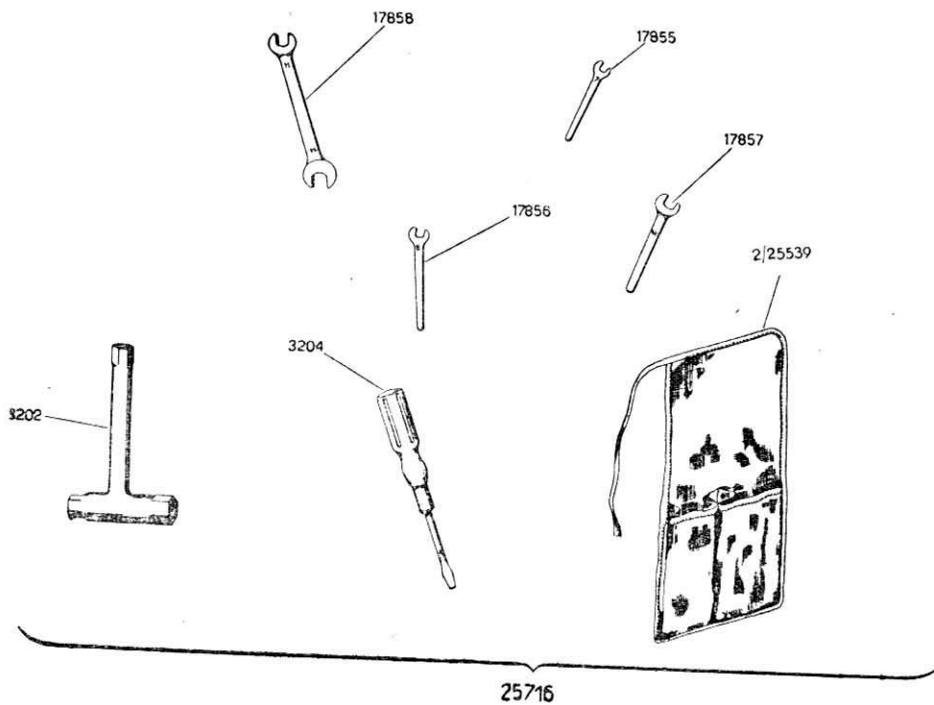

Borsa attrezzi  
Hand tools

8° Gruppo: ATTREZZI DI CORREDO  
8th Group: TOOL KIT

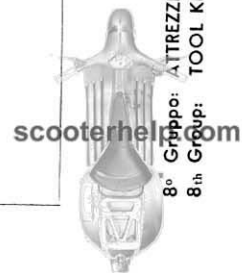

Vedere retro — P.T.O.

## T. XVIII

## Indice dei complessivi — Index of assemblies

Numero Number	Particolari componenti il gruppo Constituent group details	Numero Number	Particolari componenti il gruppo Constituent group details
25716	(3202 - 3204 - 17855 - 17856 - 17857 - 17858 - 2/25539)		



STABILIMENTO DI PONTEDERA

Ufficio Tecnico Serie

Dis. N. 88800

1ª Edizione — 1st Edition 1500/6110

1 - 10 - 1961 - Ristampa - Reprint



[scooterhelp.com](http://scooterhelp.com)





TABLES OF THE PARTS FOR VEHICLES EXPORTED TO  
AMERICA WHICH DIFFER FROM THOSE SPECIFIED  
IN THE «LIST OF SPARE PARTS FOR VESPA 150  
WITH ENGINE - FRAME PREFIX VB1».



Engine - Chassis - Speedometer - Pump

Table I

Parts not valid for America			Corresponding parts valid for America		PART NAME	Parts not valid for America			Corresponding parts valid for America		PART NAME
Number	Table	No. off	Number	No. off		Number	Table	No. off	Number	No. off	
—	—	—	603	1	Screw	22711	IV	1	27474	1	<b>Flywheel magneto</b> (22541 - 27473)
—	—	—	619	1	Washer	—	—	—	—	—	—
—	—	—	662	1	Tag	28934	XII	1	28938	1	<b>Speedometer, miles</b> (with 24817 - 24818 - 24819 - 26703 - 86588 - S.13920 - S.12113)
—	—	—	13870	1	Pump	—	—	1	80019	1	<b>Coil No. 3</b> (with 662 - 14501)
—	—	—	14501	1	Tag	—	—	—	82503	1	Plate
18306	VII	1	17337	1	Holder, licence plate	—	—	—	83640	1	<b>Engine</b> (T. I - II - III - IV - V)
—	—	—	17338	1	Plate	81280	I	1	83709	1	<b>Chassis</b> (with 2917 - 3008 - 3760 - 5082 - 11128 - 11760 - 13481 26131 - 20058 - 23978 - 26918 40292 - 40311 - 40315 - 2/40317 84794 - S.1209 - S.12343 - S.13762)
—	—	—	18474	1	Transfer	—	—	—	S. 3105	1	Washer
16414	IV	1	23922	1	<b>Stator</b> (with 16417)	81271	VII	1	S.10047	3	Screw
21438	V	1	23983	1	Terminal, L. T.	—	—	—	—	—	Screw
20843	IV	1	24016	1	<b>Coil No. 2</b> (with 662 - 14501)	S.10050	VII	1	—	—	Screw
25965	VII	7	—	—	Buffer	—	—	—	S.10781	2	Rivet
25971	VII	1	—	—	Nut	—	—	—	S.12259	2	Bolt
25995	VII	1	—	—	<b>Stirrup</b>	—	—	—	—	—	Washer
16541	VII	1	26131	1	<b>Door</b> (with 2917 - 17132 - S.10781)	S.10022	VII	3	—	—	Screw
20842	IV	1	26214	1	<b>Coil No. 1</b> (with 662 - 14501)	S.13769	VII	1	—	—	Washer
26225	VII	1	—	—	Band	—	—	—	S.14402	2	Screw
26226	VII	2	—	—	Buffer	10733	VII	1	—	—	Spacer
2790	VI	1	26918	1	Plate	16598	VII	2	—	—	Spacer
22703	IV	1	27473	1	<b>Stator</b> (603 - 622 - 624 - 625 - 3213 16416 - 16418 - 16419 - 16420 16421 - 18941 - 22096 - 22097 22098 - 23361 - 23922 - 24016 26214 - 80019 - S.3055 - S.3103 S.3105 - S.12331 - S.12332 - S.13800 - S.13801)	S. 1104	VII	4	—	—	Nut
						S.10028	VII	4	—	—	Screw



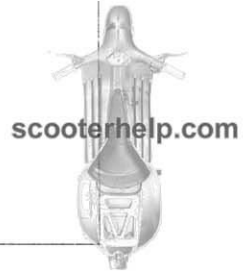
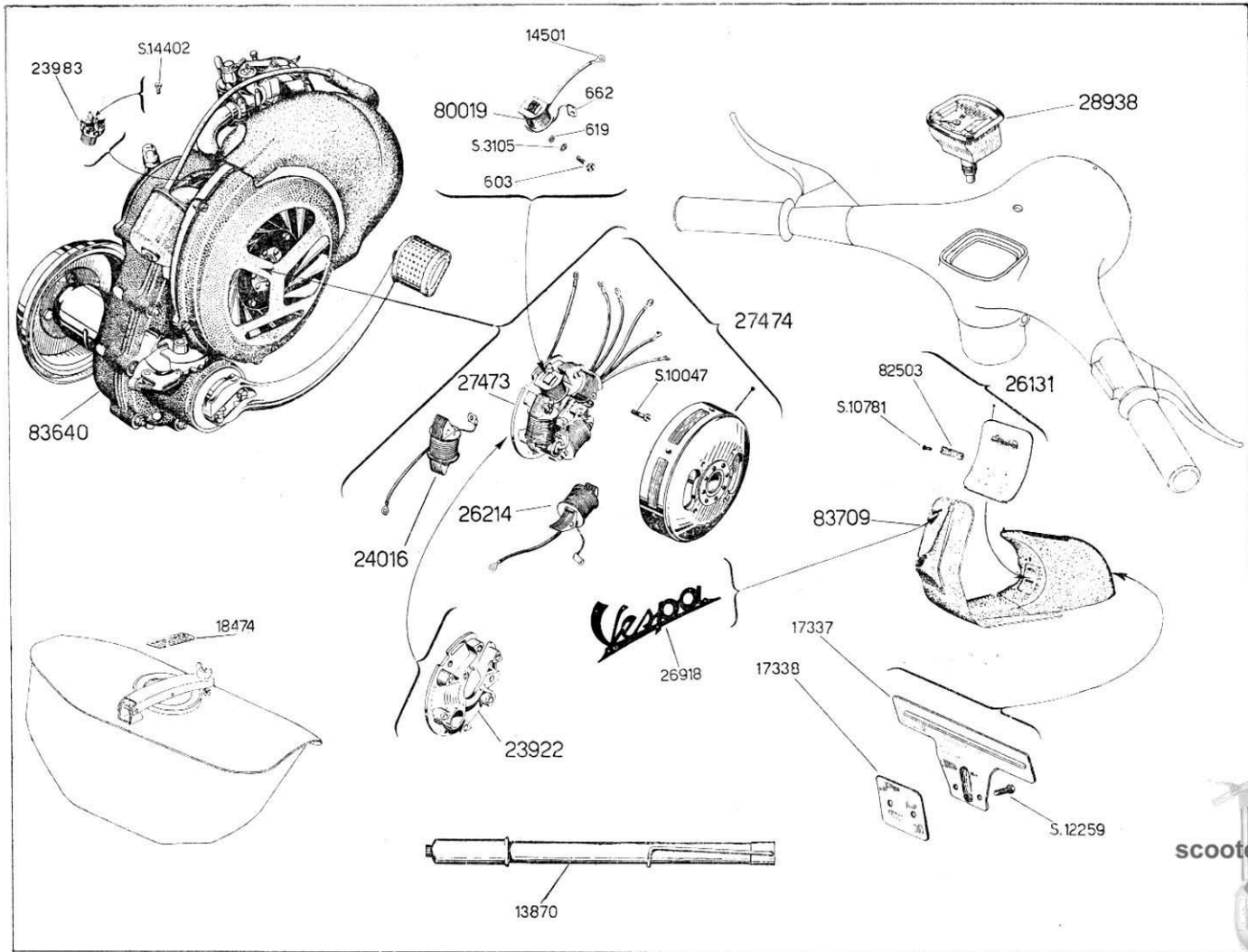



# Electric equipment

# Table II

Parts not valid for America			Corresponding parts valid for America		PART NAME	Parts not valid for America			Corresponding parts valid for America		PART NAME
Number	Table	No. off	Number	No. off		Number	Table	No. off	Number	No. off	
12128	XVI	2	—	—	Tag	25983	XV	1	—	—	Cable
14501	XV	3	—	—	Tag	<b>25984</b>	XV	1	—	—	<b>Rectifier</b>
16583	XV	1	18497	1	Bulb	26488	XV	1	—	—	Cap
11907	XV	1	18498	2	Bulb	25881	XV	1	27154	1	Board
26511	XV	1	19451	1	Bulb	25322	XV	1	81920	1	Socket, bulb
—	—	—	20913	2	Packing	<b>89471</b>	XV	1	<b>2 82033</b>	1	<b>Switch</b>
20914	XV	1	23907	1	Glass						(27154 - 28328 - 28329 - 28334 28335 - 28337 - 28338 - 28339 28341 - 28342 - 28343 - 2/28566 - 82169 - S.10054 S.13891 - S.14404)
24408	XVI	2	—	—	Nut						
<b>2/24406</b>	XVI	1	—	—	<b>Board, clamp</b>						
24429	XV	2	—	—	Tag	—	—	—	<b>82775</b>	1	<b>Stop switch</b>
24468	XV	2	—	—	Tag						(with 82778 - 82779 - 82780 82781 - 82782)
2/24967	XV	1	—	—	Fuse						
24889	XVI	1	—	—	Board, clamp	—	—	—	82778	1	Contact, L. H.
<b>21098</b>	XV	1	<b>25532</b>	1	<b>Tail lamp</b>	—	—	—	82779	1	Contact, R. H.
					(with 18425 - 20915 - 20916 - 20919 - 23907 - 26835 26836)	—	—	—	82780	2	Plate
25948	XV	1	—	—	Tag	—	—	—	82781	1	Spring
25952	XV	1	—	—	Cable	—	—	—	82782	1	Pin
25958	XV	1	—	—	Impedance	—	—	—	82783	1	Gasket
85584	XVI	1	26378	2	Tag	<b>25793</b>	XV	1	<b>82849</b>	1	<b>Head lamp</b>
26067	XVI	1	26390	1	Cable						(25479 - 25574 - 25575 - 2557 42024 - 42029 - 81920 - S.10012)
24086	XVI	1									
81081	XV	1	26835	2	Spring	—	—	—	83129	1	Sheath
81079	XV	1									
—	—	—	26836	2	Carrier	22273	XIII	1	83622	1	Rear brake pedal
25959	XV	1	—	—	Rectifier	16467	XVI	1	83639	1	Sheath
<b>82202</b>	XV	1	—	—	<b>Battery</b>	<b>81300</b>	XVI	1	<b>83642</b>	1	<b>Harness</b>
25963	XV	1	—	—	Cover						(10215 - 15468 - 17422 - 20913 22683 - 26063 - 26068 - 26069 26070 - 26377 - 26378 - 26390 42288 - 42289 - 42290 - 42291 - S.10012)
25979	XV	1	—	—	Cable						81375 - 81376 - 83129 - 83639 83643 - 83644)
25981	XV	1	—	—	Cable						



# Electric equipment

# Table II

Parts not valid for America			Corresponding parts valid for America		PART NAME	Parts not valid for America			Corresponding parts valid for America		PART NAME
Number	Table	No. off	Number	No. off		Number	Table	No. off	Number	No. off	
—	—	—	83643	1	Cable						
—	—	—	83644	1	Cable						
S. 3053	XV	1	—	—	Washer						
S. 3103	XV	2	—	—	Washer						
S. 3104	XVI	2	—	—	Washer						
S.10060	XV	1	—	—	Screw						
S.10061	XV	2	—	—	Screw						
S.12017	XVI	4	—	—	Nut						
S.13886	XVI	2	—	—	Washer						
S.13887	XVI	2	—	—	Washer						
—	—	—	S. 3104	1	Washer						
—	—	—	S.14555	1	Screw						

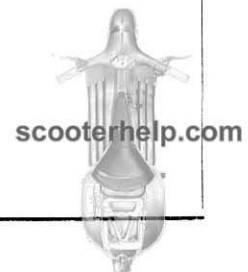

STABILIMENTO DI PONTEDERA  
UFFICIO TECNICO SERIE  
Drg. No. 88801 - 1100/6110

1 - 10 - 61 - Reprint

