

Lambretta
150 Id



**Instruction
Manual**



scooterhelp.com

Lambretta
150 Id



Instruction Manual



Here you are now in possession of the new Lambretta 150 Id, which will give you indisputable proof of the qualities you expect to find.

In effect it has been expressly designed to meet your requirements whether you think of using it for business or for pleasure purposes.

Before using your new machine remember that each mechanical organ needs care. The first thing is to consider its moving elements and their method of working; learn further all the possibilities of your Lambretta and treat it sensibly. It always pays to be

gentle with a new engine so that it turns over sweetly; by this way you will keep its essential specifications unaltered.

You will find here, briefly summarized, some fundamental hints and instructions needed by the user to avoid inconveniences and mistakes. Do not neglect to read this booklet and follow our suggestions: you will be well-rewarded by keeping your machine at its full efficiency even after long use.

We feel grateful for our choice: it will be a pleasure to count you from now on among our former Lambretta-riders.



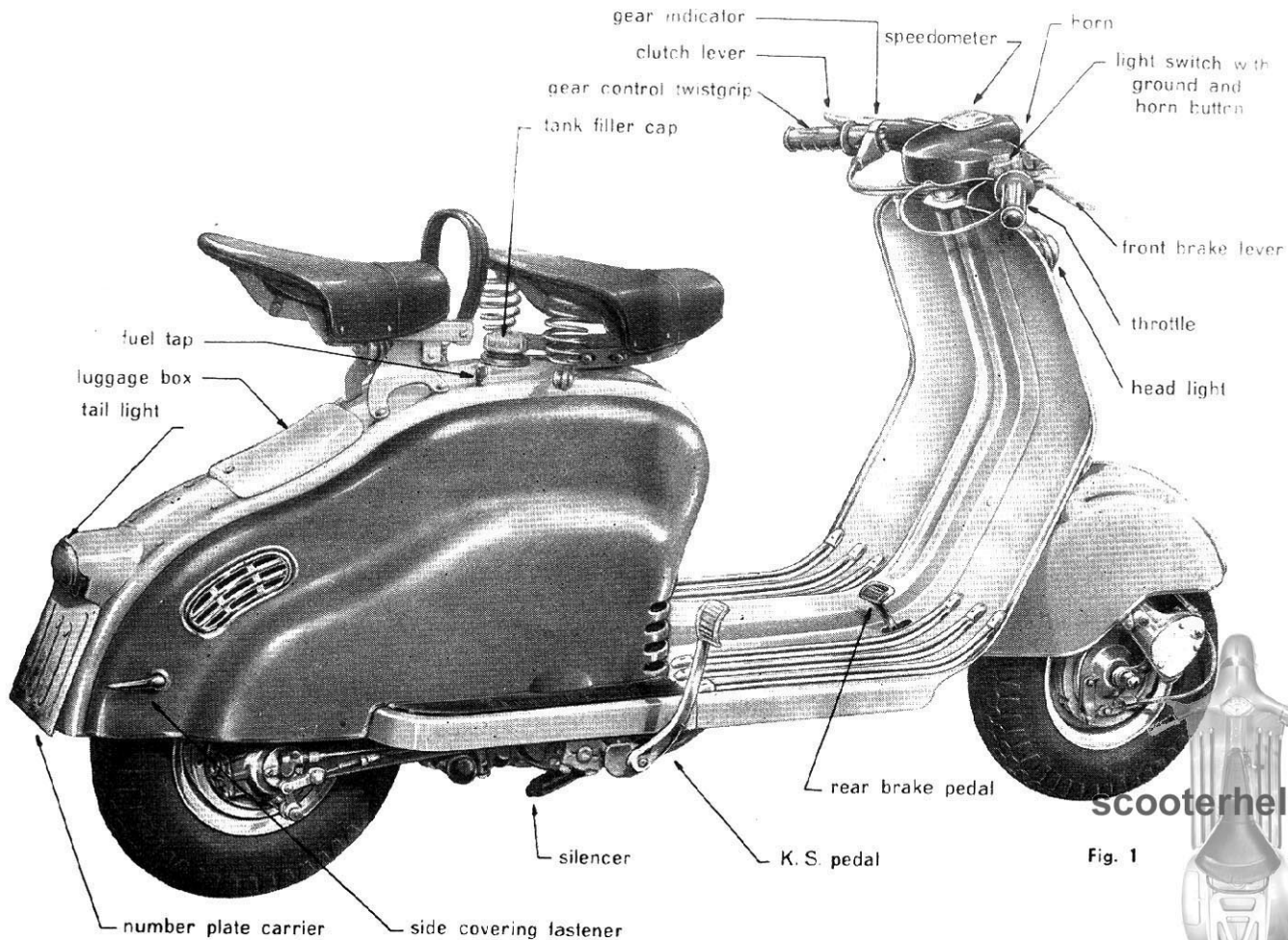

scooterhelp.com

Fig. 1

MAIN FEATURES

Vehicle

Overall length	70" (1,770 m)	Max speed 47-50 m.p.h. (75-80 km/h)
Overall height	38" (0,960 m)	Fuel consumption 110-: 120 m.p.g. at cruising speed
Ground clearance	4-3/8" (0,110 m)	Uphill: low gear 35% gear ratio 1:12,9 second gear 20% gear ratio 1: 7,5 top gear 10% gear ratio 1:4,75
Width (Handlebar)	29" (0,740 m)	Engine 2-stroke single cylinder engine
Wheelbase	50-1/2" (1,281 m)	Capacity 148 cc.
Unloaded weight	198 lbs (90 kg)	Bore 2,244" (57 mm) Stroke 2,283" (58 mm) Compression ratio 6,5 HP output max 6 r.p.m. 4600

Cylinder of high quality wear-resistant cast iron

Cylinder head of light alloy, die cast

Cast piston wear resistant of light alloy ;

Connecting rod of high-tensile steel with needle bearings on big end

Built-up crankshaft carried in ball bearings

Lubrication by petrol

Del'Orto MA 19M4 carburettor incorporating:

- starter device
- petrol filter
- silencing air cleaner with intake in « calm air »



Choke 0.748 (19 mm); max jet 0.0295 (75/100 mm)

Ignition by flywheel magneto and outside high tension coil - Automatic **advance** mechanism - 4-pole magneto (27 Watt).

Side-located spark plug. Heat range: 225 Bosch Scale.

Starting by pedal.

Forced draught cooling by fan fitted on the flywheel.

Clutch

Multi-plate type running in oil bath operated by lever on the left twistgrip. Adjusting device, just near the lever (fig. 1).

Gearbox

3-speed. Constant mesh gears in oil bath made of high-tensile steel. Hand control by left twistgrip and

flexible cable (fig. 1). Gear position indicator near the twistgrip.

Transmission

From engine to gearbox by bevel gears; from gearbox to the rear bevel gears by torsion shaft especially efficient against sudden variations of the revolution rate. Bevel gears running in oil bath. The shaft is enclosed in the transmission case A (fig. 7). The connection for the speedometer drive is to be found under the cap B (fig. 7) on the transmission case.

Frame

The frame is of a large steel tube section ensuring highest rigidity and eliminating vibration.

Suspension

The front suspension (fig. 2) is realised by means of trailing links.

Each trailing link is connected to a lever bearing an end ball which compresses a progressive **type** spring, located inside the fork tubes (A). This group is hermetically protected against water and dust and operates in the grease enclosed within the boxes (B) the result being longer working life and no

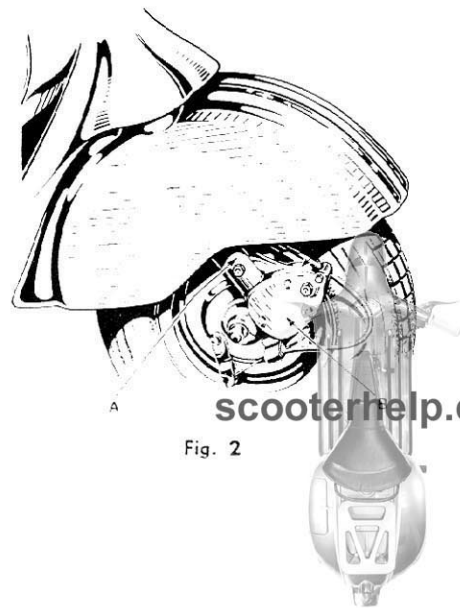
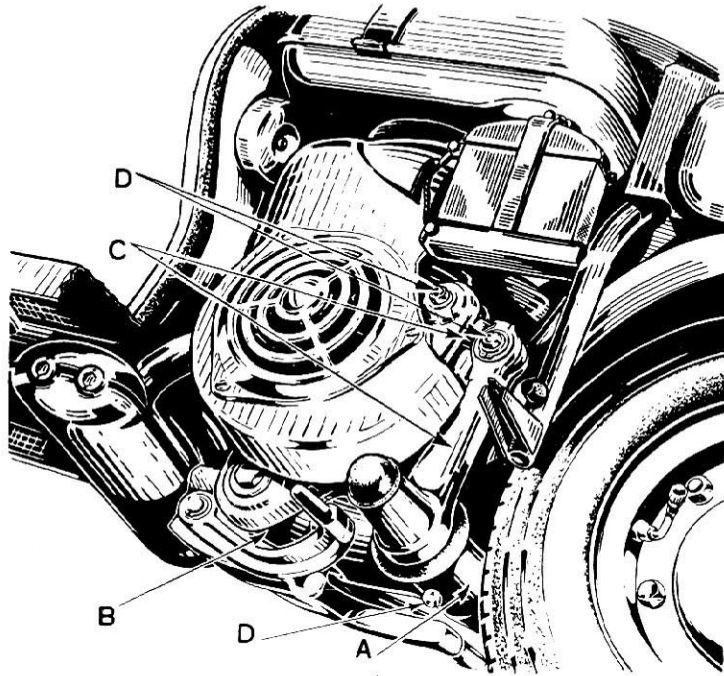

Fig. 2

scooterhelp.com

Fig. 3



maintenance. The rear suspension (fig. 3) is designed with a long swinging arm, consisting of the

transmission case A (fig. 7), and pivoting on a robust pin (B) incorporated in the frame.

Through its movement the swinging arm loads the suitably supported torsion bar made of high-tensile steel. The swings of the engine group are transmitted to the torsion bar by means of return levers (C), which are properly proportioned in order to reduce the torsion bar angle when the load increases.

The fitting of a hydraulic damper remarkably increases springing comfort.

The release lever knuckles and the bronze bushing for the torsion bar lever are lubricated by means of grease guns (D).

Brakes

Internal expanding type brakes with flexible control, operated by



WIRING DIAGRAM (Without battery)

Switch lever position

0 - Off

1 - Pilot light

2 - Beam {
dipped
main

M - Earth push button

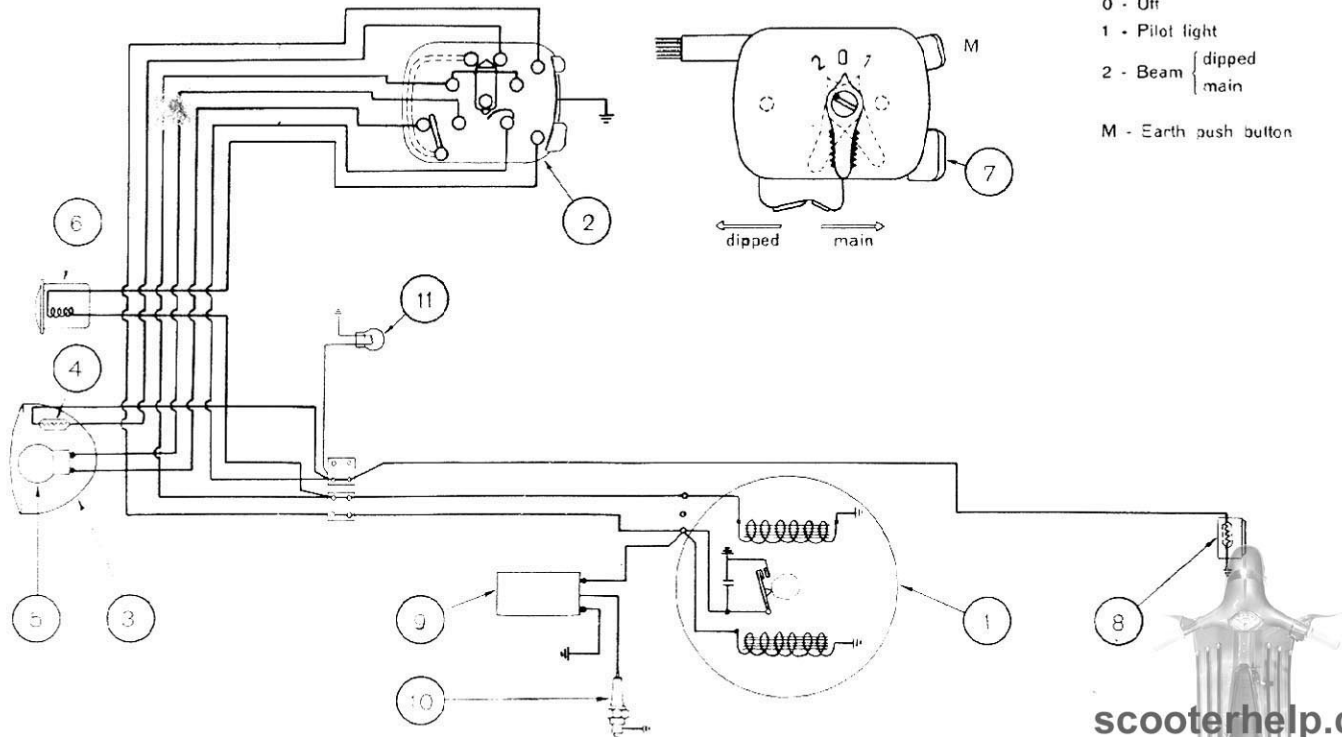

1. Flywheel magneto - 2. Lighting switch with horn button - 3. Head light - 4. Pilot light - 5. Twin-filament bulb - 6. Horn
7. Earth push button - 8. Tail light - 9. H. T. coil - 10. Spark plug - 11. Speedometer bulb.

scooterhelp.com

WIRING DIAGRAM (With battery)

Switch lever position

0 - Off

1 - Pilot light

2 - Beam } dipped
main

M - Earth push button

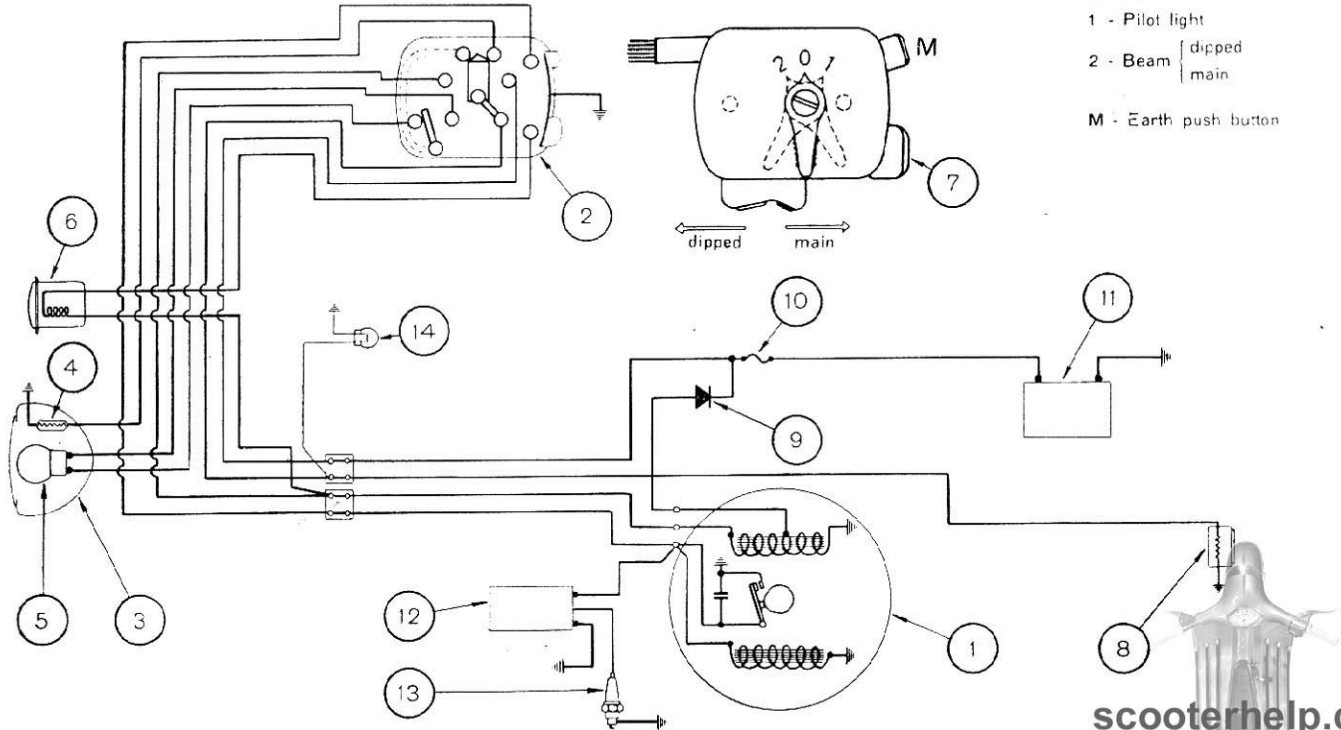

1. Flywheel magneto - 2. Lighting switch - 3. Head light - 4. Pilot light - 5. Twin filament bulb - 6. Horn - 7. Horn button -
8. Tail light - 9. Rectifier - 10. Fuse - 11. Battery - 12. H. T. Coil - 13. Spark plug - 14. Speedometer bulb

scooterhelp.com



hand on the front wheel and by pedal on the rear wheel. (See adjusting device - fig. 8).

Wheels

Interchangeable. The rear wheel is detachable like motor car wheels. Easy dismantling of the pressed steel sheet rims. 4.00-8" tyres. Inflating pressure: 14 lbs/s.i. for the front tyre 27 lbs/s.i. for the rear tyre with pillion rider.

Tank

Capacity :

1,55 gals (7,1 lt) including 1¼ pt. (0,7 lt) reserve

3-way tap (See fig. 4) :

C = close — A = open

R = reserve.

Electrical System

with pilot light (diagram No. 1) :

By alternating current generator. Headlight with 6V - 25/25W twin-filament bulb and 12V-10W pilot lamp. Tail light with red gem and 6V-3W bulb. Illuminated speedometer with 6V-1,5W bulb.

Lighting switch with separate controls, on the right handlebar, for pilot light, main beam and dipped beam, ignition earthing and horn.

Electrical system with parking light
(diagram No. 2) :

By alternating current generator supplying L.T. current to 6V-25/25W twin-filament bulb located in the head lamp, 6V-1,5W bulb located in the tail lamp and 6V-1,5W illuminated speedometer bulb. Mo-

reover it charges a 6V-4Ah battery, through a rectifier. The battery supplies direct current to the 6V-5W bulb located in the head lamp as well as to the 6V-1,5W bulb located in the tail lamp, which constitute the pilot light and parking light.

The battery may be either of dry or of common lead acid type. Lighting switch with separate controls, on the right handlebar, for pilot light, main beam and dipped beam, ignition earthing and horn.

Tool Kit

- 1 Double tubular spanner (21-14 mm = 0,827" — 0,551") for spark plug and wheel nuts.
- Double spanner (14-27 mm = 0,551"-1,06") for rear wheel hub nut



- 1 Double spanner (10-14 mm = 0.394" — 0.551") for cap screws of hexagon socket type
 - 1 Double spanner (8-10 mm = 0.315" — 0.394")
 - 1 Spanner (3,5 mm = 0.1378")
- for cap screws of hexagon socket type
- 1 Screwdriver
 - 1 Point file
- The tool bag is located inside the luggage box.

Accessories

Pillion seat, spare wheel support with carrier. All accessories can be supplied with all necessary fittings.

Safety-lock

Key safety-lock, on handlebar.



SERVICE INSTRUCTIONS

As mentioned in the Foreword, the Lambretta has been so designed as to make it accessible for everybody whatever their ages may be. No particular skill is required for its use and maintenance. However it is strongly recommended, in order to obtain a perfect running-in of the mechanical parts of the vehicle and to increase their operating life, to run with reduced throttle for the first 900 miles at a maximum speed of 35 m. p. h. and to avoid riding uphill with full throttle. The following are some hints and advice.

Fuel

Loosen the filler cap on the tank. Use only good petrol mixed with fluid oil (corresponding to SAE 30) in the following volume proportion:

8 % for the first 900 miles,
6 % afterwards.

We recommend BP-Energol Two Stroke. Before filling the tank pour petrol and oil into a tin and shake the tin to ensure an homogeneous mixture.

Never use petrol only or mixed in a lower proportion than described.

Lubricants

Check oil level through the corresponding plug holes. For lubricating the gearbox use oil corresponding to SAE 30 (BP-Energol Motor Oil SAE 30). During Summer months or in hot regions use a quality of oil corresponding to SAE 50 (BP-Energol Motor Oil SAE 50).

For transmission bevel gears the use of differential oil is recommended (BP-Energol Transmission Oil EP-SAE 140). See Lubrication Diagram.

scooterhelp.com



Spark Plug

When fitting the spark plug, make sure to adapt the washer and to locate the spark plug with the exact inclination. Do this by hand. Use the spanner for final locking only.

Carburettor

The max jet, as indicated in the Main Features, is tuned to meet every requirement under normal climatic conditions. At low or very high temperature in order to avoid troubles in the engine performance (pre-ignition, head-knocking, etc) it is advisable to change the tuning. If the jet gets clogged, unscrew and clean it.

Idle running is controlled by adjusting the air inlet horizontal

screw fitted outside the carburettor.

We recommend, when the Lambretta motor scooter is not used for a long time, to check that no petrol is let into the carburettor. Then there will be no chance of oil obstructing the jet. When next

the machine is required, rock it from side to side, to ensure that oil and petrol mix properly. To inspect the carburettor, remove the right side panel of the engine covering.

Starting

First check on the indicator to see if the gear is in neutral (between low and second gear); close throttle. Pull the button B, placed on the left hand panel, in « Av » position, and then actuate the starting pedal. When the engine has started, return button back to its initial position « M ».

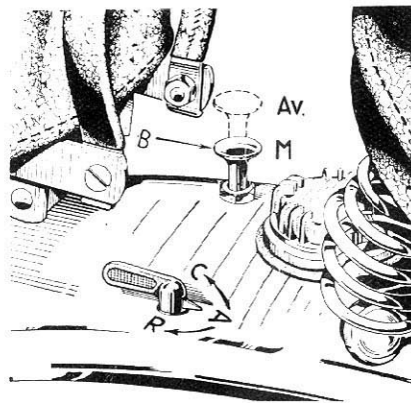

Fig. 4

Speed change

The speed change control is located on the l.h. twistgrip (fig. 1) and is hand operated. When changing speed, reduce



throttle, declutch and put in gear, smoothly rotating the twistgrip. Then gradually release the clutch operating lever and accelerate the engine especially when starting, to avoid clutch straining and engine stopping.

After a short practice these operations will be easily performed. It is advisable not to engage the clutch too quickly with the engine revolving at too high a speed in order to avoid roughness or skidding of the rear wheel. The gearbox provides three speeds with neutral between low and second gear, as clearly indicated on the gear position indicator (fig. 1).

To put in the low gear, turn the twistgrip backwards. To change up from low to second gear turn the twistgrip forwards until it locks. To shift from second to top gear com-

plete the rotation of the twistgrip. To change down from top to second gear and from second to low gear, turn the twistgrip backwards. To change up from low gear to neutral, half-rotate the twistgrip between low and second gear until you feel a slight stop.

Change gear before it is essential to avoid high engine revolutions.

Wheels and Tyres

To remove the front wheel (fig. 5), first disconnect the brake control cable (A); then loosen the two cap nuts (B) fastening the wheel to the trailing links (C); place the washers under the nuts, located within the trailing links. To remove the rim from the hub, loosen the three cap nuts (D).

To dismantle the rear wheel (see fig. 6), remove the left side panel (A) loosening the fastener (B); then loosen the three cap nuts (D) holding the wheel to the hub.

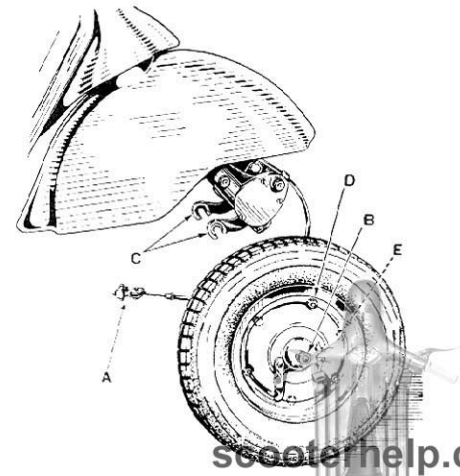

Fig. 5

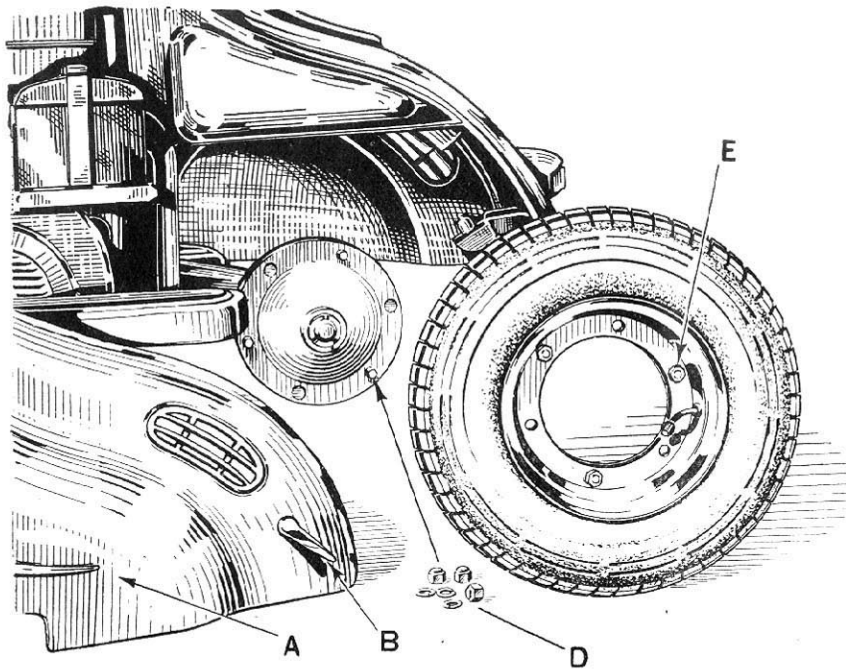

Fig. 6

Very Important

To remove the tyres from rims, loosen the remaining three nuts E (fig. 5-6) **after filling, deflating the tyres.**

Miscellaneous

During the first 900 miles (1500 km) do not race the engine or operate over 35 m. p. h. After 300 miles (500 km) it is advisable to drain oil from the gearbox and the rear bevel gear casing, and refill after washing them out with petroleum. Check the bolts on the cylinder head and tighten, if necessary. To stop engine, push the button on the lighting switch until position M is reached (See Wiring Diagram). Do not run the engine for a long time when the vehicle is at standstill. It is easy to stop and start again.



INSTRUCTIONS FOR MAINTENANCE

Every 900 miles (1500 km) (See Lubrication Diagram).

- * Check the gearbox oil level and pour oil through the plug E until it flows out of the level plug F and then add 1/4 pint oil again.
- * Lubricate by means of the greasers the rear suspension springing lever knuckles and torsion-bar lever (1), the rear brake control pin (7) and the rear brake pedal pin (8).
- * Lubricate all connections, joints, control levers with a few drops of engine oil (BP-Energol Motor Oil SAE 30).

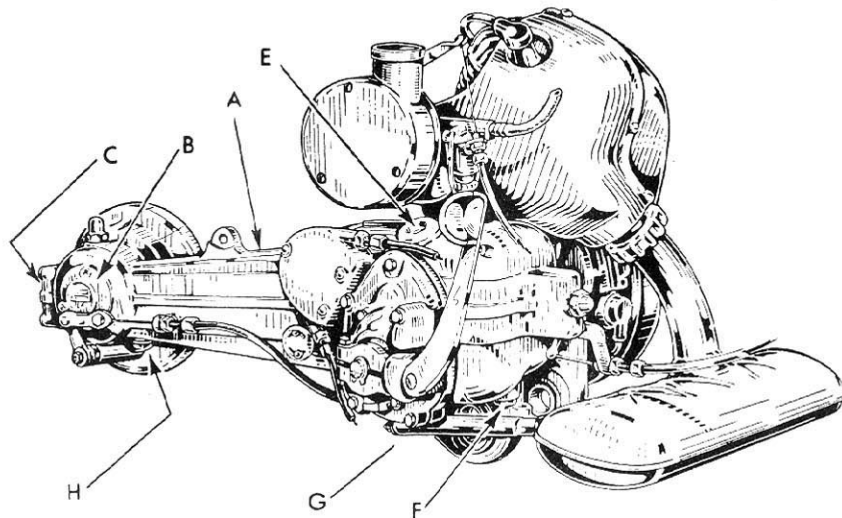

Fig. 7

Every 1800 miles (3000 km)

- * drain oil from the gearbox when the engine is warm. To drain oil remove the plug G.

- * Put in through the plug E approximately 1 pint oil.
- * Check and re-establish oil level in the rear bevel gear casing

through the cap C, serving as well to establish oil level in the casing.

- * Lubricate the front wheel bearing.

scooterhelp.com



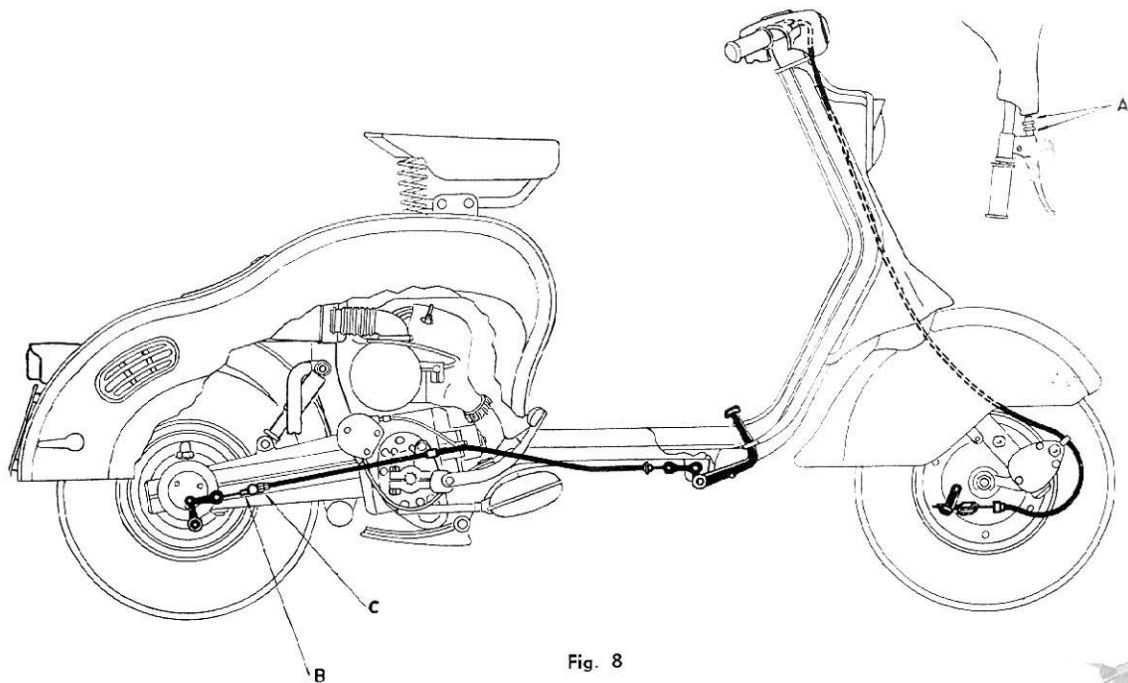

Fig. 8

ings, injecting by means of the greaser BP-Energrease L 3. Lubricate by means of the grea-

sers (10) the front suspension casings, injecting BP-Energrease A 1.

* Dismantle the carburetor filter and remove the foreign matter accumulated.

scooterhelp.com



PERIODIC MAINTENANCE

Lubricate the indicated points :

(1) Rear suspension lever knuckles and torsion bar lever (2) Gear-box : Drain and refill after the first 300 miles (500 km).

During the Summer months or in hot regions use oil corresponding to SAE 50 (BP-Energol Motor Oil SAE 50). (3) Clutch control cable knuckles. (4) Rear bevel gears. (6) Rear brake cable knuckles (7) Rear brake pin. (8) Rear brake pedal pin. (9) Front brake cable knuckles. (10) Front suspension casings and springs. (11) Front wheel bearings. (12) Front brake pin. (13) Control and lever knuckles on the handlebar (front brake, throttle, clutch and gearbox).

C = Rear bevel gear casing filler cap

E = Gearbox oil filler cap

F = Gearbox oil level cap

G = Gearbox oil drain sap

H = Rear bevel gear casing drain cap

Every 1800

Every 900

Engine view, flywheelmagneto side

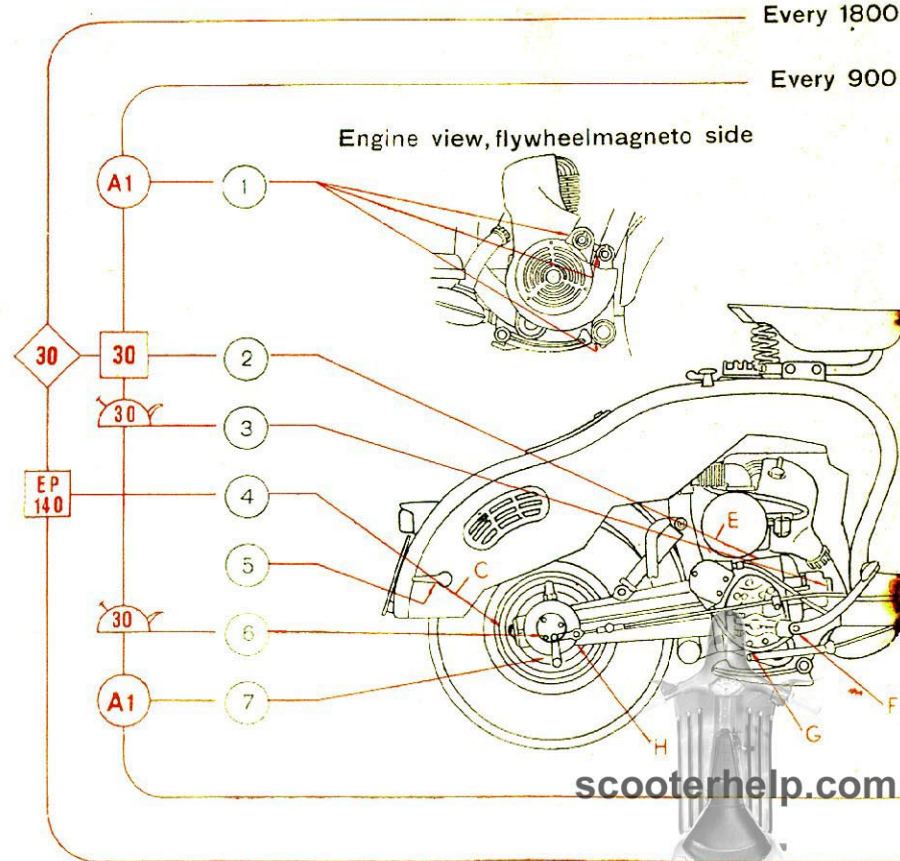

scooterhelp.com



Grease gun



Oiler



Drain oil and refill



Restablish level

N DIAGRAM

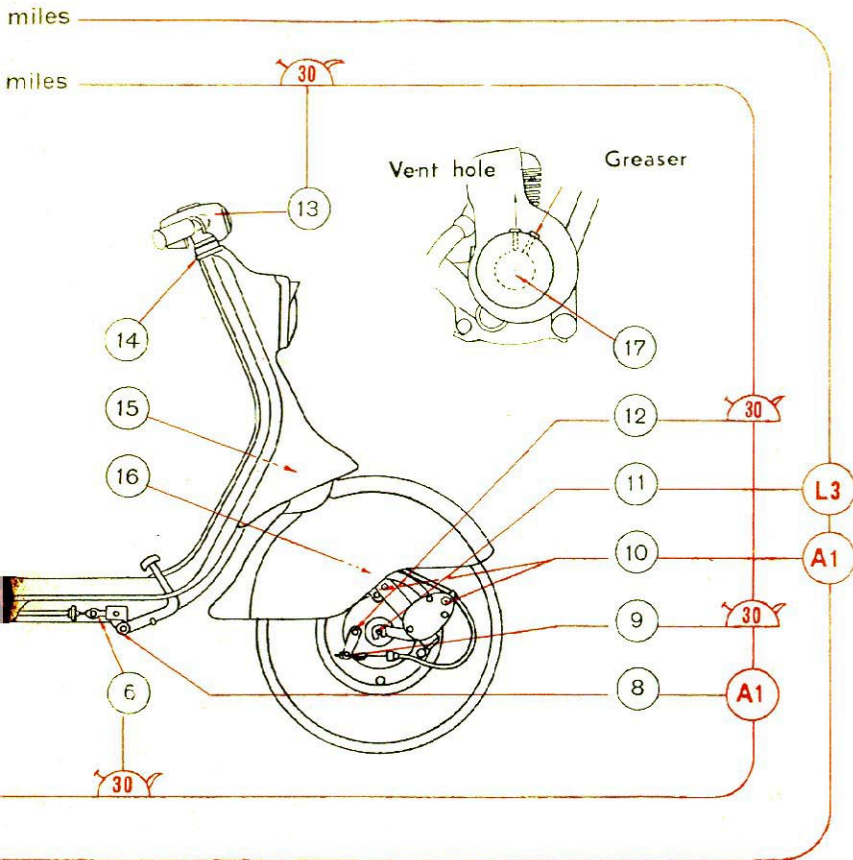

INSTRUCTIONS FOR REPAIR SHOPS

When overhauling, follow these instructions:

1. Points (3) (6) (9) (12) (13) must be lubricated **when** reassembling with BP-Energrease A 1.

2. Points (14) (15), steering ball bearings must be lubricated when reassembling with BP-Energrease L 3.

3. Points (5), side covering fasteners, must be lubricated when reassembling with BP-Energrease A 1.

4. The front suspension springs to (16), contained in the fork tubes, must be coated when reassembling with BP-Energrease A 1.

5. Fitting (17) for the bearing seat on the crankshaft, flywheel magneto side, must be filled, when mounting, with BP-Energrease L3.

Symbol explanation: 30 is BP-Energol Motor Oil SAE 30 ● A1 is BP-Energrease A1 ● L3 is BP-Energrease L3 ● EP 140 is BP-Energol Transmission Oil EP SAE 140

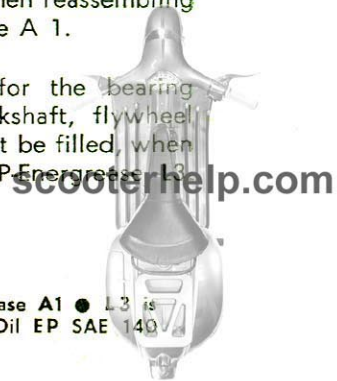

- * Free the silencer and scrape away all the carbon.

Every 3000 miles (5000 km).

- * detach the cylinder from the frame and decarbonize the piston head, the cylinder head and the exhaust port.

Every 4500 miles (7000 km).

- * Re-establish oil level by means of the greaser in the crankshaft ball bearings at the point no. 17 (flywheel magneto side):
remove the venthole cap injecting BP-Energrease L3 until it flows out of the vent hole, tighten the cap injecting 2-3 cmc. of grease.

Brake adjustment

Always apply brakes smoothly. In order to obtain a gradual braking operation, adjusters (fig. 8) need particular attention and have to be given the necessary number of turns. For the front brake adjust the nuts A on the handlebar lever; for the rear one, adjust the sleeve B and the nut C at the cable end.

Ignition

Check flywheel* magneto timing. Ignition should occur at 26° advance angle with respect to the piston u. d. p. corresponding to an arc of 1-5/16" (34 mm) on the flywheel magneto periphery.

A correct gap of 0.0197"-0.0236" (0,5-0,6 mm) must be maintained

between the spark plug electrodes and the points must be perfectly cleaned. Remove dirt using a very thin emery paper.

Cell battery (when fitted)

Care must be taken to stop discharge before plates have become sulphated as otherwise the battery is likely to deteriorate.

Dry battery: at least once a month (at high temperatures twice or thrice) add distilled water until the level of the solution reaches the tops of the plates and remains constant. Allow a quarter of an hour for the water to mix with acid and then draw up the excess of liquid with the aid of a rubber bulb.



It is advisable to add water after a run rather than before.

Lead acid battery: check liquid level monthly and in any case every 1500 km (900 miles); level should be (1,9"-3,9") 5-10 above plate tops. Add distilled water, if needed.

Take care, when filling, not to spill water over and around the cells and not to exceed specified height.

Make sure that terminal connecting the battery poles to the circuit wires are tight and coated with grease to avoid ruined battery owing to corrosion.

When removing and reinstalling the battery, watch over correct connections:

— positive pole (+) connected to the circuit wire

— negative pole (—) connected to the earth screw placed on the battery bracket.

Routine attention

In case of long inactivity, general cleaning is necessary:

- * Drain mixture from tank and carburettor bowl;
- * Clean petrol filters on the tank and the carburettor;
- * Pour some oil into the cylinder through the spark plug hole and rotate the crankshaft once or twice in order to smear the cylinder walls with a rust-preventing oil film.
- * Lift the vehicle until the tyres clear the ground and deflate the tubes.

* When the cell battery is fitted on the machine, it must be removed, kept dry and out of frost. Monthly it must be charged at a Service Station in order to maintain its full efficiency.

* Coat with rust preventing grease all metallic non-painted parts.

* Use petroleum for outside cleaning of the engine, but wash painted parts with water. Wipe the engine dry with clean rags and painted parts with chamois leather. Do not use petroleum for painted parts since it damages paint and makes it dull. Clean plastic parts (levers, lighting switch, etc.) with water and keep them away from petrol because it corrodes plastic.

* Provide a covering for the vehicle.



ELECTRIC STARTER

The Lambretta 150 c.c. is also available, as an alternative, equipped with electric starter, replacing the standard kick starter.

The new installation includes :

- Two 3-cell batteries connected in series (13 Ah capacity) which are charged by the flywheel magneto through a selenium rectifier
- Voltage regulator with fuse
- Motor
- Main switch for lighting and ignition.

Arrangement of the various elements is shown in the Scheme fig. 9.

The batteries are housed in the luggage box; the cover has been designed so as to follow the body line. This position makes batteries

easily accessible for periodic inspection.

The rectifier is properly sized; it is enclosed in a case beneath the rider's saddle.

The voltage regulator, provided with a fuse as a means of protection of the electric equipment, is rubber mounted on the frame and easily accessible by removal of the left panel.

The motor is located under the floorboard at the right side; in such a position no disturbance is caused to the rider.

Every 600 miles (1,000 km) check whether some oil from the crankcase has penetrated into the motor gear chamber.

A special threaded plug placed in the bottom of the flange allows

for the immediate draining of any oil sediment.

The main key switch controls the starting, lighting and ignition circuits; it is placed on the instrument panel and arranged conveniently to the rider's hand. There are 5 key positions, as clearly indicated in the fig. 10.

STARTING

The drive is by hand lever on the instrument panel l.h.; it operates the motor pinion through a flexible cable (Glance at the scheme, fig. 9).

Now follow this procedure:

- open the tank tap
- put the gear lever in neutral that is the position between first and second gear



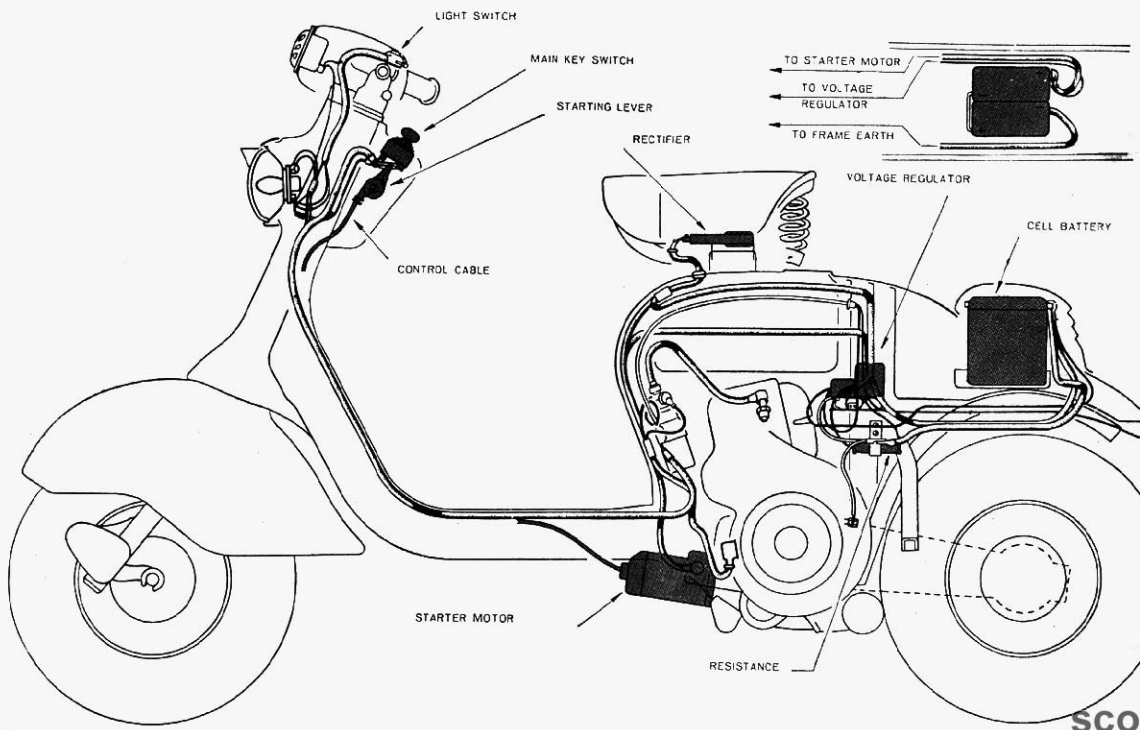

Fig. 9



- close the throttle entirely
- lift the choke knob situated behind the rider's seat, at the left side
- insert the key into the main switch hole, push it in as far as it will go and rotate it to the right to get the desired position (fig. 10).
- pull the starting lever backwards until it reaches the end of its stroke.

This action will cause the motor pinion to engage the clutch bell crown and then the electric circuit to be closed: thus the motor will be fed by the batteries and it will begin functioning.

To prevent the motor winding from being dragged by the engine when the latter has been fired, a special free wheel device has been designed in order to have the motor pi-

nion turning freely on its axle. The hand lever on the instrument panel has a small clearance beyond the stroke end stop, 0,78"-0,11" = 2-8 mm) before allowing the

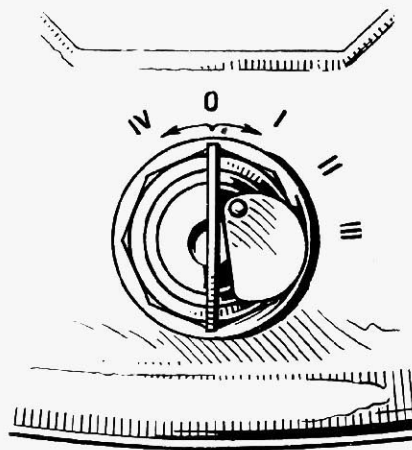

Fig. 10

- Key positions on main switch:
- O - Stationary vehicle (key off)
 - I - Lights off
 - II - Pilot lights on
 - III - Headlamp (current to double-throw switch)
 - IV - Parking lights on

shifting of the switch rod. The adjustment is effected by operating the knurled nut on the outer cable (hand lever side) which should be firmly tightened with the counternut after being adjusted. Once the engine is running, let the hand lever go: a release spring will bring the pinion to its rest position breaking the circuit to the battery. As soon as the engine has reached the normal temperature range, press the choke knob down. **To avoid severe damage to starter gears and motor do not operate the lever when the engine is running.**

Assuming the engine does not start although the motor is revolving correctly, after 3-4" release the hand lever and repeat the starting operation after 1-2". Try 4-5 times: if the engine fails



WIRING DIAGRAM (With electric starter)

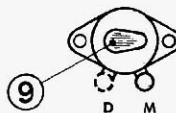
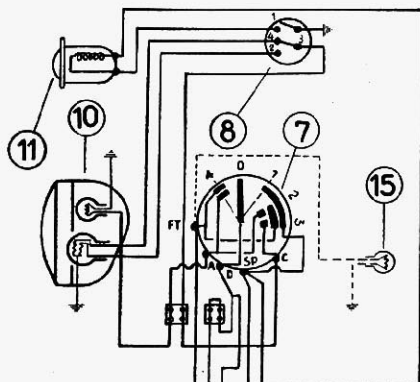

Positions of double-throw switch lever:

M = main beam
D = dipped beam

Dotted line - Speedometer bulb (optional)

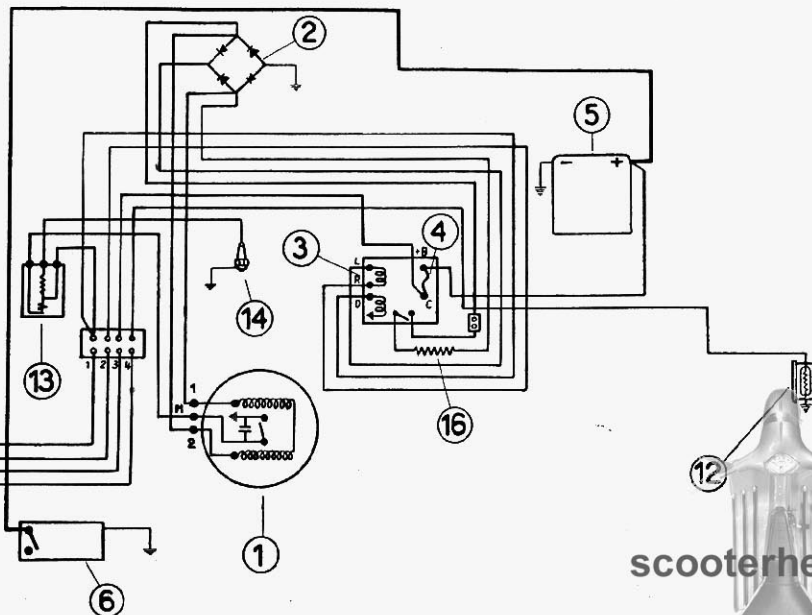

1. Flywheel magneto - 2. Rectifier - 3. Voltage regulator - 4. Fuse - 5. Cell batteries - 6. Starter motor - 7. Main switch - 8. Double-throw switch
9. Horn push button - 10. Headlamp - 11. Horn - 12. Tail lamp - 13. H. T. Coil - 14. Spark plug - 15. Speedometer bulb - 16. 3.5 Ω resistance

scooterhelp.com



to start repeat the same operation having the **throttle fully open and the choke knob pressed down**. When the engine is warm it is not necessary to operate the choke.

To stop the motor, shift the switch key to the "O" position.

When the machine is stationary do not turn the key to I, II and III position to avoid battery discharging. The key may be removed only from "O" and "IV" positions.

Important

Never turn the engine before batteries are connected to the electric circuit.

Should the engine fail to start, even if the motor operates correctly, check the lighting set and see whether the fuse has burnt.

LIGHTING SET

In the machines equipped with electric starter the lighting set is fed with 12 V direct current which is supplied by the batteries, ensuring in such a way unaltered efficient illumination at any vehicle speed. A 12V - 25/25W bilux bulb and a 12V-5W pilot lamp, also acting as a parking light, are housed in the headlamp. The tail lamp has a 12V-3W bulb. The illuminated speedometer has a 12V-1,5W bulb. Main and dipped beam are controlled by means of a double-throw switch on the right handlebar (see electric diagram). Do not fit bulbs of different rate than prescribed to avoid alteration of the charging circuit specifications.

The horn, as well as the other devices, is fed with direct current

and is controlled by button coupled to the lighting switch (lighting set).

BATTERY MAINTENANCE

Inspect the batteries at regular intervals to keep them fully efficient and avoid corrosion of the plates. Check the liquid in each cell every 900 miles and more frequently in hot weather. Electrolyte level should be 5-10 mm above the tops of the plates. Add distilled water to make up the deficiency. If liquid is spilled when filling the cells wipe with a clean rag the top of the battery and the terminals. Check every now and then the contacts between poles and terminals. They should be kept tight and smeared with whit grease to avoid corrosion. In the case the machine is to be left standing for a long time, re-



move the batteries and store them in a place where there is no danger of freezing; give them a refreshing charge monthly.

When installing the batteries make sure the poles are exactly connected to the corresponding cable terminals as indicated in the Scheme (fig. 9).

STARTING BY COLD WEATHER

When the electric starter is being operated at low temperature range (0°C) additional precautions are necessary:

- Use for mixture and gearbox extra-fluid oil corresponding

to SAE 20 (BP Energol Motor Oil SAE 20W).

- Before engaging the motor put in low gear **and** push the machine by hand for a few yards until the engine starts to revolve.

After this, remember to move the gear control **into neutral again**.



TROUBLE CHART

To eliminate troubles in engine performance, first look for the most probable cause. Recheck, if necessary, and following our directions you will locate the source of the defective operation and be able to repair it properly.

CAUSE

REMEDY

Engine fails to start or stops immediately

Faulty petrol flow to carburettor.

Tank tap closed.

Filter or fuel line clogged.

No spark or weak spark.

Check for the cause. Refill tank, if necessary.

Open the tank tap.

Clean filter or fuel line.

Check H. T. contact on the flywheel - Tighten the cable to the terminal - adjust electrode gap to 0.0197" - 0.0236" (0.5-0.6 mm).

Engine knocks

Incorrect fuel.

Preignition.

Overheated.

Drain and replace with correct fuel.

Clean spark plug. Adjust magneto breaker points.

Allow to cool.

Engine missing

Incorrect electrode gap.

Spark plug dirty.

Magneto breaker points dirty.

Adjust electrode gap.

Clean spark plug.

Clean accurately.



scooterhelp.com

FRENCH GUINEA - SOCIETE COMMERCIALE DE L'OUEST AFRICAINE
CONAKRY.

FRENCH GUYANA - F. TANON & CIE
CAYENNE

FRENCH SOMALILAND - ANCIENS COMP-TOIRS RIES
P.o.Box 116 - DJIBOUTI

GABON (A.E.F.) - HATTON e COOKSON
LIBREVILLE.

GOLD COAST - A. G. LEVENTIS & CO. LTD
LAGOS

GREAT BRITAIN-IRELAND - LAMBRETTA
CONCESSIONAIRES LTD.
424-426 Kingston Road - Raynes Park -
LONDON S. W. 20.

GREECE - ETALLAS S. A.
3, Kaisareias Street
ATHENS

GUADELOUPE - COMPTOIR BOREL e GIRARD
B. P. 62
POINTE à PITRE

GUATEMALA - FEDERICO BOEF E CO. LTD.
GUATEMALA - 12 calle 3-20

HAITI - LUCIANI BERMANN
Rue du Mag.de l'Etat - PORT AU PRINCE

HAWAI - SCHUBERT'S CYCLERY STORES
819-15 King Street - HONOLULU

HOLLAND - J. LEONARD LANG
Stadhouderskade, 114 E - AMSTERDAM Z.

HONG KONG - FING LEE CYCLES LTD
149, Hennessy Road - HONG KONG

ICELAND - ORKA LTD.
Laugaveg 166 - REYKJAVIK.

INDIA - AUTOMOBILE PRODUCTS OF IN-
DIA LTD
Agra Road - BHANDUP - BOMBAY

INDONESIA - ERIKA CONCERN N. V.
I, Merdeka Barat - DJAKARTA

IRAN - SOCIETE ANONYME NOUR
Avenue Lalezar - TEHERAN

ISRAEL - KOOR INDUSTRIES AND CRAFTS
CO. LTD.
115 Allenby Road - TEL AVIV.

ITALIAN SOMALILAND - FRANCESCO
BOERO
P.o. Box 23 - MOGADISCIO

IVORY COAST - C.E.C.A.
ABIDJAN.

KENYA - See: British East Africa

LA REUNION - SAMAT
Boîte Postale 10 - POINTE DES GALETS.

LIBAN - IBRAHIM R. AUDI
B. P. 316
BEYROUTH

LYBIA - LIBIA MOTOR S.p.A.
Sciara Istiklal 358 - TRIPOLI

MADAGASCAR - SOCIETE DESCOURS &
CABAUD - B. P. 757 - TANANARIVE

MALTA - MIZZI BROTHERS LTD.
283, Kingsway - VALLETTA

MARTINIQUE - EDOUARD BOULLANGER
FILS - B. P. 315 - FORT DE FRANCE

MAURITIUS - ADAM & CO LTD.
1, Queen Street - PORT LOUIS

MEXICO - LAURENCE P. SOURS -
Av. Morelos 89 - MEXICO D.F.

MOROKKO - FORGES DE BAZAS
Rue de Bazas 31 - CASABLANCA.

MOZAMBIQUE - SOCIEDADE COMMERCIAL
ITALO MOZAMBICANA
Caixa Postal 1209 - LOURENCO MARQUES

NEW AUSTRALIAN GUINEA - W. R. CAR-
PENTER & CO. LTD.
16 O'Connell Street - SYDNEY N.S.W.

NEW CALEDONIA - COMPTOIR BARRAU
NOUMEA

NEW DUTCH GUINEA - NIEW GUINEA IM-
PORT EXPORT MAATSHAPPY N. V.
HOLLANDIA

NEW ZEALAND - P. COUTTS & CO LTD.
Grey Lynn - 116 Great North Road -
AUCKLAND W. 2

NICARAGUA - MANTICA FRANCISCO &
CIA LTD.
MANAGUA - Apartado Postal 789

NIGER (A.O.F.) - COMPAGNIE DU NIGER
FRANCAIS
NIAMEY.

NIGERIA - A. G. LEVENTIS & CO. LTD.
LAGOS.

NORTH BORNEO - BORNEO MOTORS LTD.
70, Orchard Road - SINGAPORE

NORWAY - B. A. BERG & CO.
Calmeyers Gate, 14 - OSLO

OUBANGUI CHARI (A.E.F.) - SOCIETE COM-
MERCIALE DU KOUILOU NIARI
BANGUI.



PAKISTAN - J. TYLER & CO.
Mc Leod Road - KARACHI

PANAMA - B. L. LEVY
Calle 1-a n. 15 - PANAMA CITY

PARAGUAY - NICOLAS PORZIO
Calle Palma 295 - ASUNCION

PERSIAN GULF
BARRAK ABDULMOHSIN ALAQUIL & CO.
KUWAIT (Arabia)

PERU' - NIZZOLA & CO
Carabaya 801 - Casilla 907 - LIMA

PHILIPPINES - NATIONAL MERCHANDISING CO.
41, Nagtahan Street - MANILA

PORTUGAL - MOTO LAMBRETTA PORTUGUESA LTD.
Avenida Republica 36 A - LISBOA

PUERTO RICO - MARTORIANI MOTORS INC.
Av. Ponce de Leon 1402
SANTURCE

RHODESIA - MILLAR ROAN & CO. LTD.
Leander Hotel Buildings, 130 Rhodes Street - BULAWAYO.

SAUDI ARABIA - SAMI KUTBI & BROTHERS
B.o. Box 247 - JEDDAH

SENEGAL MAURITANIE - S. A. FENWICK
6, av. Gambetta - DAKAR

SIAM - THAI IMPORT EXPORT CO.
179, Surawongse Road - BANGKOK

SIERRA LEONE - THE UNITED AFRICA CO.
LTD.
FREETOWN.

SOUTH AFRICA - LAMBRETTA SALES LTD.
205, Fox Street - JOHANNESBURG

SOUTH WEST AFRICA - METJE & ZIEGLER LTD.
P.o. Box 239 - WINDHOEK

SPAIN - LAMBRETTA LOMOCIONES S.A.
Apartado, 137 - EIBAR

SPANISH MOROKKO - VIMAR S.A.
Calvo Sotelo, 16 - TETUAN

SUDAN (Fr.) - ETS. VEZIA
BAMAKO.

SWEDEN - BIL & TRUCK
Odinsplatsen, 9 - GOTEBOG

SWITZERLAND - JAN S. A.
6, Petit Rocher - LAUSANNE

TAHITI - ETS. MARCEL LASSERRE
B. P. 487 - PAPEETE

TANGANYIKA - See: British East Africa

TANGERI - USEMC S. A.
3, av. du Dr. Guita - TANGERI

TCHAD - S.TE COMMERCIALE DU KOUILOU
NIARI
FORT LAMY.

TOGO (A.O.F.) - UNITED AFRICA CO.
LOME.

TUNISIE - SOCIETE TUNISIENNE AUTOMOBILE
TUNIS - 8 rue de Grèce

TURKEY - F.LLI ALIOTTI
B. P. 362 - IZMIR

UGANDA - See: British East Africa

UNITES STATES OF AMERICA
INNOCENTI CORPORATION
Lambretta Division
43 West, 61 st. Street
NEW YORK, 23 N. Y.
ANDERSON MOTORCYCLE SUPPLY CO
(Western States Parts Distributors)
8314, South Central Avenue
LOS ANGELES, 1

URUGUAY - SIAM TORCUATO DI TELLA S.A.
Av. da Uruguay 1123 - MONTEVIDEO

VENEZUELA - IVENSA INTERNACIONAL VENEZOLANA
Correos del Este - Apartado 4393 - CARACAS

VIETNAM - VINACO
35 Rue Phu-Kiêt - SAIGON.

YEMEN - PAUL RIES & SONS LTD.
HODEIDAH

ZANZIBAR - See: British East Africa

ITALY

AGRIGENTO - Dr. SALVATORE CAPIZZI
Via Imera 19, tel. 19-36.

ALBA - F.LLI CAPRA
Corso M. Coppino 5, tel. 11-99.

ALESSANDRIA - GUALA & C. s.r.l.
Via Marengo 1, tel. 5005.

ANCONA - ALBERTO BETTITONI
Via Giannelli 1-bis, tel. 24-947.

AOSTA - VITTORIO APST...
Via Xavier de Maistre 20, tel. 21-13.

AREZZO - LUIGI AGNELLI
Via Garibaldi 109, tel. 25-24.



scopoterhelp.com

ASCOLI PICENO - « ASCO » ASCOLANA
SCOOTERS.

Via della Repubblica, tel. 35-77.

ASTI - COMETA S.r.l.

Corso Cavour 29, tel. 19-67.

AVELLINO - GIUSEPPE BELLUCCI

Via Gramsci 8, tel. 16-41.

AVEZZANO (Roma)

DITTA DE NICOLA NINO

Via C. Corradini, 98, tel. 117.

BARI - S.A.C.A.R.

LAMBRETTA S.r.l.

Piazza Umberto 51, tel. 10-496.

BARI - Dr. R. PIERI & V. OMATI

Via De Giosa 10-12, tel. 13-494.

BARLETTA (Bari) - NUNZIO DI LEO

Piazza Tramvia, tel. 10-67.

BASSANO DEL GRAPPA (Vicenza)

BERTI SERGIO E MARIO

Via Verci 27, tel. 23-532.

BELLUNO - VITTORIO D'INCA' LEVIS

Via S. Pietro 3, tel. 41-88.

BENEVENTO - METALMECCANICA SANNITA

Piazza Bissolati 13, tel. 15-54.

BERGAMO - MASSIMO MASSERINI

Via A. Maj 14, tel. 38-96.

BIELLA - S.A.S. MARCELLO RAMELLA & C.

Viale Macallè 31, tel. 23-268.

BOLOGNA - C.I.S.A. S.r.l.

Via Ugo Bassi 31, tel. 31-432.

BOLZANO - GARAGE TOURING

di Mario Kettmeier

Via Cavour 23, tel. 53-53.

BORGOMANERO (Novara)

GIUSEPPE SAVOINI & Figli

Corso Sempione 35, tel. 81-494.

BRA (Cuneo) - FRATELLI MONCHIERO

Via Vitt. Veneto 137.

BRESCIA - NELLO BRINIS & C.

Corso Magenta 39, tel. 27-260.

BRESCIA - ARTURO PETACCIA

Via Dante 4, tel. 63-61.

BRINDISI - OC. RA

Corso Garibaldi 3, tel. 1182.

BUSTO ARSIZIO - MARA MARIO

Via Galilei 2, tel. 34-321.

CAGLIARI - IN.CO.SA. S.r.l.

Via Dante 105, tel. 49-42.

CALTAGIRONE - GIACOMO GATTUSO

Via Roma 217, tel. 14-31.

CALTANISSETTA - COSENTINO & GRIMALDI

Via Redentore 19.

CAMPOBASSO - NICOLA MUCIACCIA

C.so Mazzini 31, tel. 41-09.

CARCARE (Savona) - GIUSEPPE BILLIA

Via Garibaldi 43, tel. 11.

CARPI (Modena) - COMMISSIONARIA

LAMBRETTA CARPI S.r.l.

Via Ciro Menotti 2, tel. 61-787.

CARRARA (Apuania) - BATTISTA PIERI

Via Roma 36, tel. 29-84.

CASALE MONF. - GIOVANNI CORNALEA

Via Morozzo di S. Michele 18, tel. 29-40.

CASERTA - AUTOMOTO CASERTANA

Via C. Battisti 38-40, tel. 28-149.

CASSINO (Frosinone) - F.LLI CORVI

Via Roma, tel. 174.

CASTELLAMMARE DI STABIA (Napoli)

GARAGE OMNIA DI F. INGENITO

Piazza Circumvesuviana

CATANIA - S.V.A.M.

Via Francesco Crispi 199/201 - tel. 24.112

CATANIA - C.A.L.B.I. S.p.A.

Via Pacini, Palazzo I.N.A.

CATANZARO - EUGENIO CHIODO

Corso Mazzini 5, tel. 17-27.

CECINA (Livorno) - LUIGI VENTURI

Corso Matteotti 96, tel. 73-030.

CESENA (Forlì) - ANTONIO GIACOMONI

& F. S.p.A.

Via C. Battisti 1, tel. 124.

CHIAVARI (Genova) - BOGGIO DOMENICO

Piazza Stazione, tel. 25-04.

CHIETI

MARINOZZI & PIERMATTEO

Corso Maruccino 124.

CIVITAVECCHIA (Roma) - SORATEC S.r.l.

P. Santo Spirito 7, tel. 33-01.

COMO - ORESTE PEVERELLI

Via Rubini 18, tel. 19-11.

CONEGLIANO (Treviso)

MODELO CORRADO - Via Fenzi, 6.

tel. 5205.

COSENZA - Rag. RAOUL MIGLIANO

Via Alimena 49, tel. 03-04.

CREMA - LECCARDI LODOVICO

Via A. Fino 64, tel. 22-89.

CREMONA - BRUNO BARBIERI

Via Trento Trieste 132-134.

CUNEO - CHIANALE NATALE

Corso Gesso 11-bis.



PAKISTAN - J. TYLER & CO.
Mc Leod Road - KARACHI

PANAMA - B. L. LEVY
Calle 1-a n. 15 - PANAMA CITY

PARAGUAY - NICOLAS PORZIO
Calle Palma 295 - ASUNCION

PERSIAN GULF
BARRAK ABDULMOHSIN ALAQUIL & CO.
KUWAIT (Arabia)

PERU - NIZZOLA & CO
Carabaya 801 - Casilla 907 - LIMA

PHILIPPINES - NATIONAL MERCHANDISING CO.
41, Nagtahan Street - MANILA

PORTUGAL - MOTO LAMBRETTA PORTUGUESA LTD.
Avenida Republica 36 A - LISBOA

PUERTO RICO - MARTORIANI MOTORS INC.
Av. Ponce de Leon 1402
SANTURCE

RHODESIA - MILLAR ROAN & CO. LTD.
Leander Hotel Buildings, 130 Rhodes Street - BULAWAYO.

SAUDI ARABIA - SAMI KUTBI & BROTHERS
B.o. Box 247 - JEDDAH

SENEGAL-Mauritanie - S. A. FENWICK
6, av. Gambetta - DAKAR

SIAM - THAI IMPORT EXPORT CO.
179, Surawongse Road - BANGKOK

SIERRA LEONE - THE UNITED AFRICA CO. LTD.
FREETOWN.

SOUTH AFRICA - LAMBRETTA SALES LTD.
205, Fox Street - JOHANNESBURG

SOUTH WEST AFRICA - METJE & ZIEGLER LTD.
P.o. Box 239 - WINDHOEK

SPAIN - LAMBRETTA LOCOMOCIONES S. A.
Apartado, 137 - EIBAR

SPANISH MOROKKO - VIMAR S. A.
Calvo Sotelo, 16 - TETUAN

SUDAN (Fr.) - ETS. VEZIA
BAMAKO.

SWEDEN - BIL & TRUCK
Odinsplatsen, 9 - GOTEBOG

SWITZERLAND - JAN S. A.
6, Petit Rocher - LAUSANNE

TAHITI - ETS. MARCEL LASSERRE
B. P. 487 - PAPEETE

TANGANYIKA - See: British East Africa

TANGERI - USEMC S. A.
3, av. du Dr. Guita - TANGERI

TCHAD - S.TE COMMERCIALE DU KOUILOU
NIARI
FORT LAMY.

TOGO (A.O.F.) - UNITED AFRICA CO.
LOME.

TUNISIE - SOCIETE TUNISIENNE AUTOMOBILE
TUNIS - 8 rue de Grèce

TURKEY - F.LLI ALIOTTI
B. P. 362 - IZMIR

UGANDA - See: British East Africa

UNITES STATES OF AMERICA
INNOCENTI CORPORATION
Lambretta Division
43 West, 61 st. Street
NEW YORK, 23 N. Y.
ANDERSON MOTORCYCLE SUPPLY CO
(Western States Parts Distributors)
8314, South Central Avenue
LOS ANGELES, 1

URUGUAY - SIAM TORCUATO DI TELLA S.A.
Av. da Uruguay 1123 - MONTEVIDEO

VENEZUELA - IVENSA INTERNACIONAL VENEZOLANA
Correos del Este - Apartado 4393 - CARACAS

VIETNAM - VINACO
35 Rue Phu-Kiét - SAIGON.

YEMEN - PAUL RIES & SONS LTD.
HODEIDAH

ZANZIBAR - See: British East Africa

ITALY

AGRIGENTO - Dr. SALVATORE CAPIZZI
Via Imera 19, tel. 19-36.

ALBA - F.LLI CAPRA
Corso M. Coppino 5, tel. 11-99.

ALESSANDRIA - GUALA & C. s.r.l.
Via Marengo 1, tel. 5005.

ANCONA - ALBERTO BETTITONI
Via Giannelli 1-bis, tel. 24-947.

AOSTA - VITTORIO APOSTOLO
Via Xavier de Maistre 20, tel. 21-9

AREZZO - LUIGI AGNELLI
Via Garibaldi 109, tel. 25-24.



ASCOLI PICENO - « ASCO » ASCOLANA
SCOOTERS.

Via della Repubblica, tel. 35-77.

ASTI - COMETA S.r.l.

Corso Cavour 29, tel. 19-67.

AVELLINO - GIUSEPPE BELLUCCI

Via Gramsci 8, tel. 16-41.

AVEZZANO (Roma)

DITTA DE NICOLA NINO

Via C. Corradini, 98, tel. 117.

BARI - S.A.C.A.R.

LAMBRETTA S.r.l.

Piazza Umberto 51, tel. 10-496.

BARI - Dr. R. PIERI & V. OMATI

Via De Giosa 10-12, tel. 13-494.

BARLETTA (Bari) - NUNZIO DI LEO

Piazza Tramvia, tel. 10-67.

BASSANO DEL GRAPPA (Vicenza)

BERTI SERGIO E MARIO

Via Verci 27, tel. 23-532.

BELLUNO - VITTORIO D'INCA' LEVIS

Via S. Pietro 3, tel. 41-88.

BENEVENTO - METALMECCANICA SANNITA

Piazza Bissolati 13, tel. 15-54.

BERGAMO - MASSIMO MASSERINI

Via A. Maj 14, tel. 38-96.

BIELLA - S.A.S. MARCELLO RAMELLA & C.

Viale Macallè 31, tel. 23-268.

BOLOGNA - C.I.S.A. S.r.l.

Via Ugo Bassi 31, tel. 31-432.

BOLZANO - GARAGE TOURING

di Mario Kettmeier

Via Cavour 23, tel. 53-53.

BORGOMANERO (Novara)

GIUSEPPE SAVOINI & Figli

Corso Sempione 35, tel. 81-494.

BRA (Cuneo) - FRATELLI MONCHIERO

Via Vitt. Veneto 137.

BRESCIA - NELLO BRINIS & C.

Corso Magenta 39, tel. 27-260.

BRESCIA - ARTURO PETACCIA

Via Dante 4, tel. 63-61.

BRINDISI - OC. RA

Corso Garibaldi 3, tel. 1182.

BUSTO ARSIZIO - MARA MARIO

Via Galilei 2, tel. 34-321.

CAGLIARI - IN.CO.SA. S.r.l.

Via Dante 105, tel. 49-42.

CALTAGIRONE - GIACOMO GATTUSO

Via Roma 217, tel. 14-31.

CALTANISSETTA - COSENTINO & GRIMALDI

Via Redentore 19.

CAMPOBASSO - NICOLA MUCIACCIA

C.so Mazzini 31, tel. 41-09.

CARCARE (Savona) - GIUSEPPE BILLIA

Via Garibaldi 43, tel. 11.

CARPI (Modena) - COMMISSIONARIA

LAMBRETTA CARPI S.r.l.

Via Ciro Menotti 2, tel. 61-787.

CARRARA (Apuania) - BATTISTA PIERI

Via Roma 36, tel. 29-84.

CASALE MONF. - GIOVANNI CORNALEA

Via Morozzo di S. Michele 18, tel. 29-40.

CASERTA - AUTOMOTO CASERTANA

Via C. Battisti 38-40, tel. 28-149.

CASSINO (Frosinone) - F.LLI CORVI

Via Roma, tel. 174.

CASTELLAMMARE DI STABIA (Napoli)

GARAGE OMNIA DI F. INGENITO

Piazza Circumvesuviana

CATANIA - S.V.A.M.

Via Francesco Crispi 199/201 - tel. 24.112

CATANIA - C.A.L.B.I. S.p.A.

Via Pacini, Palazzo I.N.A.

CATANZARO - EUGENIO CHIODO

Corso Mazzini 5, tel. 17-27.

CECINA (Livorno) - LUIGI VENTURI

Corso Matteotti 96, tel. 73-030.

CESENA (Forlì) - ANTONIO GIACOMONI

& F. S.p.A.

Via C. Battisti 1, tel. 124.

CHIAVARI (Genova) - BOGGIO DOMENICO

Piazza Stazione, tel. 25-04.

CHIETI

MARINOZZI & PIERMATTEO

Corso Maruccino 124.

CIVITAVECCHIA (Roma) - SORATEC S.r.l.

P. Santo Spirito 7, tel. 33-01.

COMO - ORESTE PEVERELLI

Via Rubini 18, tel. 19-11.

CONEGLIANO (Treviso)

MODELO CORRADO - Via Fenzi, 6.

tel. 5205.

COSENZA - Rag. RAOUL MIGLIANO

Via Alimena 49, tel. 03-04.

CREMA - LECCARDI LODOVICO

Via A. Fino 64, tel. 22-89.

CREMONA - BRUNO BARBIER

Via Trento Trieste 132-134.

CUNEO - CHIANALE NATALE

Corso Gesso 11-bis.



DARFO (Brescia) - ANDREA ZOPPETTI
tel. 34.

DOMODOSSOLA (Novara)
SBARDELLATI LUCIANO
Via F.lli di Dio 19, tel. 22-52.

ENNA - LIBORIO BRUNO & C.
Piazza Neglia 3, tel. 1395.

ERBA (Como) - CARLO VALSECCHI
Via Milano 2, tel. 61-470.

ESTE (Padova)
FERRARESE UMBERTO & C. S.r.l.
Piazza Maggiore 27, tel. 15-04.

FAENZA (Ravenna) - S.I.M.M.A. S.r.l.
Via D. Torelli 1-B, tel. 820.

FELTRE (Belluno) - ORESTE BRANDALISE
Via Tezze 5, tel. 32-56.

FERRARA - Dr. GULINATI CARLO ALBERTO
Via Bologna 142, tel. 6120.

FIRENZE - F.lli PRESENTI S.A.I.
Via Giotto 28, tel. 62-201.

FIRENZE - GARAGE ZANIRATTI S.r.l.
Via F.lli Rosselli 55, tel. 45-341.

FOGGIA - SALDEST
Via 24 Maggio 34, tel. 11-36.

FOLIGNO (Perugia) - PAOLO NEGRI
Via Rutili 2-F, tel. 23-36.

FORLI' - PIERI GIORGIO
Corso della Repubblica 70, tel. 21-95.

FORLI' - F.lli BAGNOLI
Viale Vittorio Veneto 31, tel. 2084.

FORMIA (Latina) - OFF. GARAGE TATTA
Via Vitruvio 115, tel. 41.

FROSINONE (Roma) - F.LLI CORVI
Corso della Repubblica 50, tel. 3739.

GALLARATE (Varese) - FRANCO NOSEDA
Via Mercanti 8, tel. 20-139.

GENOVA - VINELLI & C. S.r.l.
Via Dante 59-R, tel. 51-773.

GENOVA - CAROTTI & C. S.a.s.
Via Federico Avio 43-r, tel. 41149

GORIZIA - ALDO MEROLLI
Via Garibaldi 5, tel. 27-23.

GROSSETO - COSTANZO ARZILLA
Via Gramsci 2, tel. 28-21.

IMOLA (Bologna) - CREMONINI ENZO
Via Emilia 243, tel. 262.

IMPERIA - PAOLO BARNATO
Via Garessio 2, tel. 84-02.

ISERNIA (Campobasso)
Med. d'Oro TULLIO TEDESCHI
Corso Garibaldi 27, tel. 2460.

IVREA (Torino) - GUIDO ENRIELLO
Via D'Azeglio 38, tel. 41-81.

LANCIANO (Chieti) - LUIGI MERCANDANTE
Via Luigi De Crechio, 10 - tel. 32-49.

L'AQUILA - CESARE FIAMMA
Piazza Regina Margherita 8, tel. 81-63.

LA SPEZIA - ROSSI NELLA in COZZANI
Via Di Monale, 21-23 r.

LATINA - BODEMA S.r.l.
Via E. di Savoia 20, tel. 36-27

LECCE - C.I.R. di SALVATORE LEGGIERI
Via 95° Fanteria 3, tel. 1097.

LECCO (Como) - SPREAFICO ROMANO
Corso Alberto 4, tel. 47-50.

LEGNAGO (Verona)
MOTO AGRICOLA di ZUCCATO
Corso della Vittoria 10, tel. 20-033.

LEGNANO (Milano) - MORANDI NAZZARO
C.so Garibaldi 7, tel. 48-803.

LIVORNO - A.I.C.A. s.r.l.
P.za D. Chiesa 14, tel. 24-266.

LODI - Ditta GIORGIO ESPOSTI
Via Solferino 27, tel. 30-43.

LUCCA
GIOVANNI MEI di ALBERTO & GIOVANNI
Via Fillungo 195, tel. 60-83.

LUGO (Ravenna)
DITTA MUCCINELLI BRUNO
Via Baracca 59, tel. 2053.

MACERATA - OFF. MECCANICA OSVALDO
GRANDONI & FIGLIO
Via S. Lucia 2, tel. 25-25.

MANTOVA - ALDO MINGHETTI
Via Principe Amedeo, 26-A

MASSA - S.C.A.M.
Viale Democrazia 1, tel. 74-23.

MATERA - S.V.E.A.R. S.r.l.
Via Lucana 126, tel. 11-04.

MERANO (Bolzano)
AUTORIMESSA CENTRALE S.r.l.
Via delle Corse 31, tel. 13-30.

MESSINA - GIANNETTO & CUCINOTTI
Via dei Verdi 20, tel. 10-705.

MILANO - MINETTI S.p.a.
Via Filelfo 7, tel. 981-987.

MILANO - MILANO SCOOTER S.r.l.
Via Paullo 11, tel. 580-670.



MODENA - M.C.M. S.r.l.
Via Emilia 251, tel. 24-800.

MONDOVI' (Cuneo) - AIRALDI STEFANO
Corso Statuto, 14, tel. 2374.

MONZA (Milano) - GHEFER & C. S.N.C.
Via C. Alberto 22, tel. 20-30.

NAPOLI - SCOOTER del Dr. L. CASTINO
Via Nazario Sauro 30-32, tel. 62-983.

NAPOLI - ITALMOTOR S.r.l.
P.za Capuana 13, tel. 52-157.

NOVI LIGURE - BONELLI LUIGI
Via Pavese 3, tel. 2037.

NUORO - RONDONI GIACOMO
Piazza Vitt. Emanuele.

ODERZO (Treviso) - F.LLI SCARDELLATO SAS
Via Garibaldi 6-12, tel. 20.

ORVIETO - F.LLI STORTI
P.za Repubblica 16, tel. 51-38.

PADOVA - GIAMPIETRO TUROLLA
Via Foscolo 13-c, tel. 27-104.

PALERMO - CUTRANO S.r.l.
Via Stabile 226, tel. 18-009.

PALERMO - CA-SAR di ADELE CASTELLINO
Via Roma 330-332, tel. 13-197.

PAOLA (Cosenza)
DITTA GALOMINO CUSTODIO
Via del Cannone.

PARMA - MORDACCI MARIO
Via della Repubblica 8, tel. 22-187.

PAVIA - GIOVANNI VENCO & C.
Via Gilardelli 14, tel. 32-28.

PERUGIA - TAGLIAMONTE ARTURO
Via L. Masi 8, tel. 20-220.

PESARO - MOCHI ZAMPEROLI L.
C. XI Settembre 310, tel. 12-45.

PESCARA - RADAR di VITTORIO LUCIANI
Corso Italia, 45-47.

PIACENZA - BARIOLA MARCELLO
Via Colombo 44, tel. 30-07.

PINEROLO (Torino)
CAROSSO GIUSEPPE
Via Carlo Alberto 9, tel. 27-08.

PIOMBINO (Livorno) - GERI TEMISTE
Corso Italia 76, tel. 22-68.

PISA - DEL SEPPIA LIVIO & C.
Via C. Cattaneo 1, tel. 30-25.

PISTOIA - EMPORIO DELL'AUTO
C. Vitt. Emanuele 23, tel. 24-44.

PORDENONE (Udine) - MOTOMECCANCA
Corso Garibaldi 42, tel. 23-22.

PORDENONE (Udine) - DITTA BRISOTTO BRUNO
Corso Garibaldi, 31, tel. 2613.

PORTO SAN GIORGIO (Ascoli Piceno)
PETRACCI FERRUCCIO
Via Naz. Adriatica, tel. 92-48.

POTENZA - RUSSO BERARDINO
C.so Mazzini - Palazzo Tripaldi - tel. 13-64.

RAGUSA - BAIELE GIORGIO
C.so Italia 90, tel. 11-31.

RAVENNA - DE STEFANI E.
Via Rasponi 2, tel. 11-83.

REGGIO CALABRIA - S.A.M.O.R. S.r.l.
Viale Amendola 29, tel. 11-83.

REGGIO EMILIA - S.C.I.A.M.
Via Emilia San Pietro 55, tel. 2676.

RIETI - ANGELETTI AGOSTINO
Piazza C. Battisti 8-9, tel. 32-28.

RIMINI - ADRIATICA SCOOTER di Ing. F. CAVARA & G. VETTORI
P.za 3 Martiri 45, tel. 25-39.

ROMA - CA.MA.RA.
Via S. Nicolò da Tolentino 5, tel. 61-872.

ROVERETO (Trento) - MANICA EMILIO
V.le Dante 43/45, tel. 3778.

ROVIGO -
GINO GIUSEPPE MANTOVANI
Via Umberto I° 31, tel. 13-29.

SALERNO - Comm. Rag. D'AVOSSA ANDREA
Via Garibaldi 103, tel. 1151.

SALO' (Brescia) - FRANCESCHI ATTILIO
Via S. Carlo 19, tel. 431.

SALUZZO (Cuneo)
DITTA MIOLANO FRANCESCO
Via Torino 82, tel. 2356.

SAN MARINO - A. RIGHI
Piazze del Mercato 129 - tel. 168 - Borgomaggiore.

SANREMO (Imperia) - LUIGI BRUZZONE
C.so Garibaldi 2, tel. 54-77.

SASSARI - IN.CO.SA.
Via dei Mille, tel. 21-56.

SAVONA - CICLI PORASSO
Corso Italia 19/21, tel. 21924.

SESTRI LEVANTE (Genova)
O.M.E.R. AGROFOLIO & RAMPONE
Via Nazionale 119, tel. 41276.

SIENA - Cav. CAMILLO VANNOCCI
Via Piave 4, tel. 26-705.



SIRACUSA - VINCENZO D'AMICO URSO
Via dei Miracoli 39, tel. 19-58.

SONDRIO - OTTORINO RUFFINI
Via Trento 6/c

SPOLETO (Perugia) - F. VANTAGGIOLI
Via Trento Trieste 18, tel. 51-45.

SULMONA (L'Aquila)
ALBERTO SACCHETTA
Via Occidentale 111, tel. 2173.

TARANTO - GERARDO BARDICCHIA
Piazza Massari 1, tel. 15-85.

TERAMO - F.lli di BONAVENTURA
Via Delfico 61, tel. 52-85.

TERNI - GIUSEPPE BELLÌ
Via Lungonera, 55.

TIVOLI (Roma) - BRUNO PACIFICI
Viale Tomei 21, tel. 3032.

TORINO - DARIO VICO
Via Filadelfia 51, tel. 393.161.

TORTONA (Alessandria)
ROLANDI RICCARDO
Via Circonvallazione 145, tel. 257.

TRAPANI - ATTILIO AMODEO
Via Virgilio 16, tel. 15-51.

TRENTO - DITTA MARTINO AICHNER
P. Venezia 15, tel. 31-13.

TREVIGLIO (Bergamo) - O.R.V.A.M.
Viale C. Battisti 5-c., tel. 2191.

TREVISO - S.G.A.M. di A. COMIRATO
Via S. Nicolò 11, tel. 27-12.

TRIESTE - FILOTECNICA GIULIANA S.r.l.
Via Carducci 7, t. 23279.

UDINE - NELLO BRINIS & C.
Via Poscolle 43, tel. 27-07.

UDINE - EMPORIO FRIULANO
Via Palladio 6, tel. 83-50.

URBINO (Pesaro)
URBINO AUTO SCOOTER
C.so Garibaldi 19, tel. 194.

VARESE - CARLO FELICE BUZIO
Via Orrigoni 2, tel. 39-73.

VASTO (Chieti) - SAVERIO BACCALA'
Corso Garibaldi, 123.

VELLETRI (Roma) - GIUSEPPE RONSINI
Viale Roma 14, tel. 26-096.

VENEZIA (Mestre) - GIAMPIETRO TUROLLA
Via Piave 145, t. 56094.

VERBANIA - VERBANA MOTOR S.r.l.
C.so Mameli 55, tel. 96-42.

VERCELLI
CASA DELLA MOTO di FABIO TAVANTI
Corso Prestinari 26, tel. 3468.

VERONA - S.R.A.M.
Via Nizza 5, tel. 38383.

VERONA - SO.VE.MO.
Volto Cittadella 18, tel. 55-01.

VIAREGGIO (Lucca)
Cav. SEM. DE RANIERI
Via Garibaldi 6, tel. 24-25.

VICENZA - LEONE CHIARELLO
Porta Padova 82, tel. 36-46.

VIGEVANO (Pavia) - ABELE CERASTICO
Via Ceresotti 5, tel. 25-76.

VITERBO - MOTOSPORT di P. MARINELLI
Via Orologio Vecchio 22, tel. 26-40.

VITTORIO VENETO (Treviso)
DITTA MARCHIO' GIUSEPPE
Via Casoni 5, tel. 2333.

VOGHERA (Pavia) - S. MONTAGNA & C.
Via Don Minzoni 10, tel. 52-82.

scooterhelp.com





scooterhelp.com

PRINTED IN ITALY

STAB. POL. G. COLOMBI S.P.A. MILANO



In your own interest

**ASK AND ACCEPT
ONLY ORIGINAL SPARE PARTS**

Lambretta

The **INNOCENTI** Co.
supplies,
through its agent,
original spare parts
in sealed packing
or with
a guarantee badge

The prices of original
spare parts are
fixed by a price list
which is available upon request.
No price increase allowed



scooterhelp.com